

INSTALLATION AND OPERATING INSTRUCTIONS

↳ BIOCLASS HM

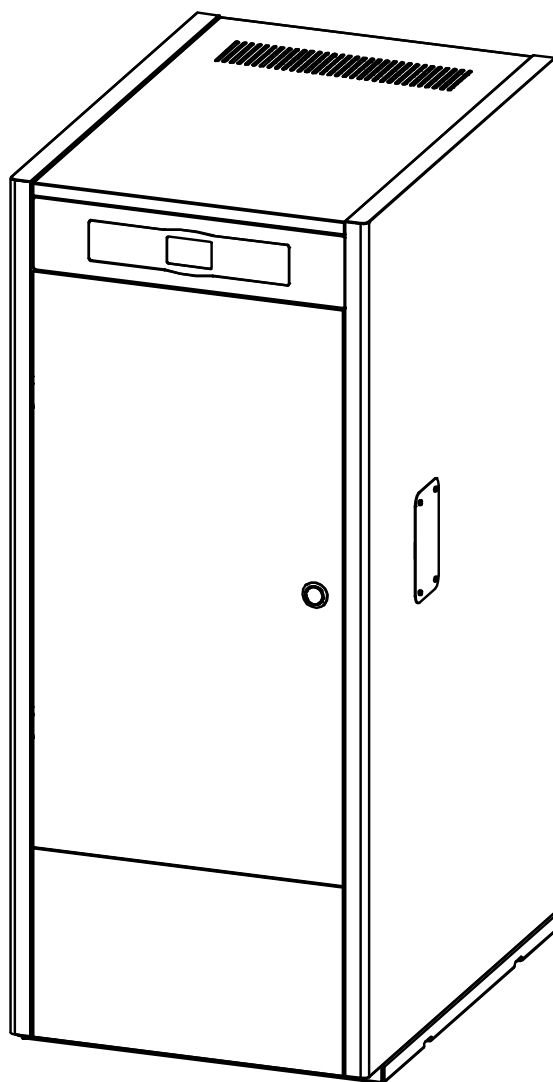

DOMUSA
T E K N I K

Thank you for choosing a DOMUSA TEKNIK heating boiler. Within the product range offered by **DOMUSA TEKNIK** you have chosen **BioClass HM** model. With a suitable hydraulic installation and with a correct fuel, this boiler will provide the ideal level of comfort for your home.

This manual forms an essential part of the product and it must be given to the user. We recommend you read the warnings and recommendations in the manual carefully, as they contain important information on the safety, use and maintenance of the installation.

These boilers must be installed by qualified personnel only, in accordance with the legislation in force and following the manufacturer's instructions.

Commissioning of these boilers and any maintenance operations must only be carried out by **DOMUSA TEKNIK's** Authorised Technical Assistance Services.

Incorrect installation of these boilers could result in damage to people, animals or property, and the manufacturer will hold no liability in such cases.

DOMUSA TEKNIK informs all parties concerned that, in compliance with section 1 of the first additional provision of Law 11/1997, the responsibility for delivering packaging waste or used packaging for its proper environmental management will be that of the final owner of the product (Article 18.1 Royal Decree 782/1998). At the end of its useful life, the product must be taken to a selected collection point for electrical and electronic equipment or must be returned to the distributor at the time of purchasing a new equivalent appliance. For more detailed information on the collection schemes available, contact either the collection facilities of the local authority or the distributor where the purchase was made.

INDEX

	Page
1 LIST OF COMPONENTS.....	3
2 CONTROL COMPONENTS.....	4
3 INSTALLATION INSTRUCTIONS	5
3.1 LOCATION	5
3.2 HYDRAULIC INSTALLATION.....	5
3.3 INSTALLING A SANIT HOT WATER TANK (OPTIONAL).....	6
3.4 FUEL	6
3.5 INSTALLING THE HOPPER	7
3.6 ELECTRICAL CONNECTION.....	8
3.7 COMBUSTION PRODUCT REMOVAL.....	8
3.8 BIO HYDRAULIC KIT INSTALLATION.....	9
3.9 INSTALLATION WITH A BT BUFFER TANK (OPTIONAL).....	10
3.10 INSTALLATION WITH A BT-DUO BUFFER TANK (OPTIONAL).....	14
4 COMMISSIONING OF THE BOILER	16
4.1 PRIOR WARNINGS	16
4.2 ELECTRICAL CONNECTION.....	16
4.3 FILLING THE INSTALLATION.....	16
4.4 INITIAL CALIBRATION OF THE FEED AUGER	16
4.5 COMMISSIONING.....	16
4.6 INSTALLATION DELIVERY	17
5 DIGITAL DISPLAY.....	18
6 OPERATION.....	21
6.1 "ONLY HEATING" OPERATION.....	21
6.2 OPERATING WITH A SANIT DHW TANK (OPTION).....	21
6.3 BOILER TEMPERATURE SET POINT SELECTION.....	22
6.4 DHW TEMPERATURE SET POINT SELECTION (WITH DHW TANK INSTALLED ONLY).....	22
6.5 SELECTING THE SETPOINT TEMPERATURE OF THE BUFFER TANK (ONLY WITH BUFFER TANK).....	23
6.6 FUNCTIONING ACCORDING TO OUTDOOR TEMPERATURE CONDITIONS OTC (OPTION).....	23
7 OPERATING WITH BIO HYDRAULIC KITS (OPTIONAL).....	24
8 OPERATION WITH A BT BUFFER TANK (OPTIONAL)	25
8.1 OPERATION WITH A TEMPERATURE SENSOR IN THE BT BUFFER TANK (P.08 = 1 OR 2).....	25
8.2 OPERATION WITH A CONTROL THERMOSTAT IN THE BT BUFFER TANK (P.08 = 3 OR 4).....	26
9 OPERATION WITH A BT-DUO BUFFER TANK (OPTIONAL).....	27
10 OPERATING WITH LAGO FB OT+ REMOTE CONTROL (OPTIONAL).....	28
11 USER MENU	29
11.1 ASHTRAY STATUS.....	30
12 SETUP MENU	31
12.1 TIMERS PROGRAMMING PROCESS.....	32
12.2 BOILER TIMER PROGRAMMING	32
12.3 CVS SUCTION SYSTEM TIMER PROGRAMMING (CVS SUCTION SYSTEM OPTION ONLY).....	32
12.4 DHW RECIRCULATION FUNCTION TIMER PROGRAMMING (DHW TANK OPTION ONLY).....	33
12.5 TIME SETTING	33
12.6 ASHTRAY EMPTY WARNING FUNCTION.....	34
12.7 MANUAL SETTING OF FEED AUGER CALIBRATION.....	34
12.8 SCREEN CONTRAST SETTING.....	34
13 CALIBRATION MENU	35
13.1 FEED AUGER FILLING.....	36
13.2 FEED AUGER CALIBRATION	37
13.3 MANUAL SETTING OF FEED AUGER CALIBRATION.....	38
13.4 MANUAL ASH CLEANING ACTIVATION.....	38
13.5 MANUAL CIRCULATION PUMPS ACTIVATION	38
14 TECHNICAL MENU	38
14.1 ENTRY AND SET THE ACCESS CODE ("COD", P.25).....	41
15 BOILER'S SETUP PARAMETERS.....	42
15.1 BOILER MODEL (P.01)	42
15.2 BOILER HEAT OUTPUT (P.02, P.03).....	42

BioClass HM

15.3 GENERAL FAN SPEED FACTOR (P.04)	42
15.4 FUEL FOR IGNITION (P.05)	42
15.5 FUEL CONSUMPTION (P.06)	42
15.6 FUEL TYPE (P.07)	42
15.7 MANAGING BT AND BT-DUO BUFFER TANKS (P.08, P.28).....	43
15.8 AUXILIARY PARAMETER FOR FUEL SELECTION (P.26).....	43
15.9 BOILER MINIMUM TEMPERATURE MODE (P.13, P.14)	43
16 HEATING CIRCUIT'S SETUP PARAMETERS.....	43
16.1 HEATING PUMP POST-CIRCULATION TIME (P.15).....	43
16.2 BOILER'S PUMP OPERATING MODE (P.18)	44
16.3 MINIMUM BOILER WATER PRESSURE (P.19).....	44
16.4 MAXIMUM HEATING FLOW TEMPERATURE OF MIXED CIRCUITS (P.27)	44
17 DHW CIRCUIT'S SETUP PARAMETERS.....	44
17.1 DHW INSTALLATION MODE (P.09).....	44
17.2 DHW PUMP POST-CIRCULATION TIME (P.16).....	44
17.3 LEGIONELLA PROTECTION FUNCTION (P.17).....	45
17.4 DHW RE-CIRCULATION FUNCTION (P.20 = 2).....	45
18 ADDITIONAL FUNCTIONS.....	45
18.1 CVS SUCTION SYSTEM CYCLE TIME (P.22).....	45
18.2 RESET DEFAULT VALUES (P.24)	45
18.3 PUMPS ANTI-LOCK FUNCTION.....	45
18.4 ANTI-FROST FUNCTION.....	45
18.5 BOILER PRESSURE SENSOR FUNCTION	45
18.6 CONNECTING THE LAGO FB OT+ REMOTE CONTROL.....	46
18.7 ROOM THERMOSTAT CONNECTION	46
19 MULTI-FUNCTIONAL RELAY (P.20)	46
19.1 BOILER ALARMS EXTERNAL SIGNAL (P.20 = 1)	46
19.2 DHW RE-CIRCULATION FUNCTION (P.20 = 2).....	46
19.3 AUTOMATIC WATER FILLING FUNCTION (P.20 = 3)	47
20 CLEANING THE ASH DRAWER	48
20.1 SAFETY WARNINGS:	48
21 SAFETY LOCK-OUTS.....	49
21.1 WATER OVERHEAT SAFETY LOCK-OUT (E-11)	49
21.2 FUEL ENTRANCE TUBE OVERHEAT SAFETY CUT-OUT (E-05)	49
21.3 LOW PRESSURE LOCK-OUT	50
22 SHUTTING DOWN THE BOILER.....	50
23 EMPTYING THE BOILER	50
24 BOILER MAINTENANCE	50
24.1 FREQUENCY OF MAINTENANCE OF THE BOILER AND CHIMNEY	50
24.2 BURNER CLEANING PROCEDURE	51
24.3 HEAT EXCHANGER CLEANING PROCEDURE	52
24.4 DRAINING THE CONDENSATE WATER	53
24.5 BOILER WATER CHARACTERISTICS.....	53
25 DIAGRAMS AND MEASUREMENTS.....	54
26 CONNECTIONS DIAGRAM.....	57
26.1 BOILER	57
26.2 BURNER.....	58
27 ELECTRICAL DIAGRAM.....	59
28 CHARACTERISTICS OF THE CIRCULATION PUMP.....	60
28.1 CHARACTERISTICS OF THE SC PUMP	60
29 SPARE PARTS LIST	64
30 TECHNICAL DATA	72
31 ALARM CODES	74

1 LIST OF COMPONENTS

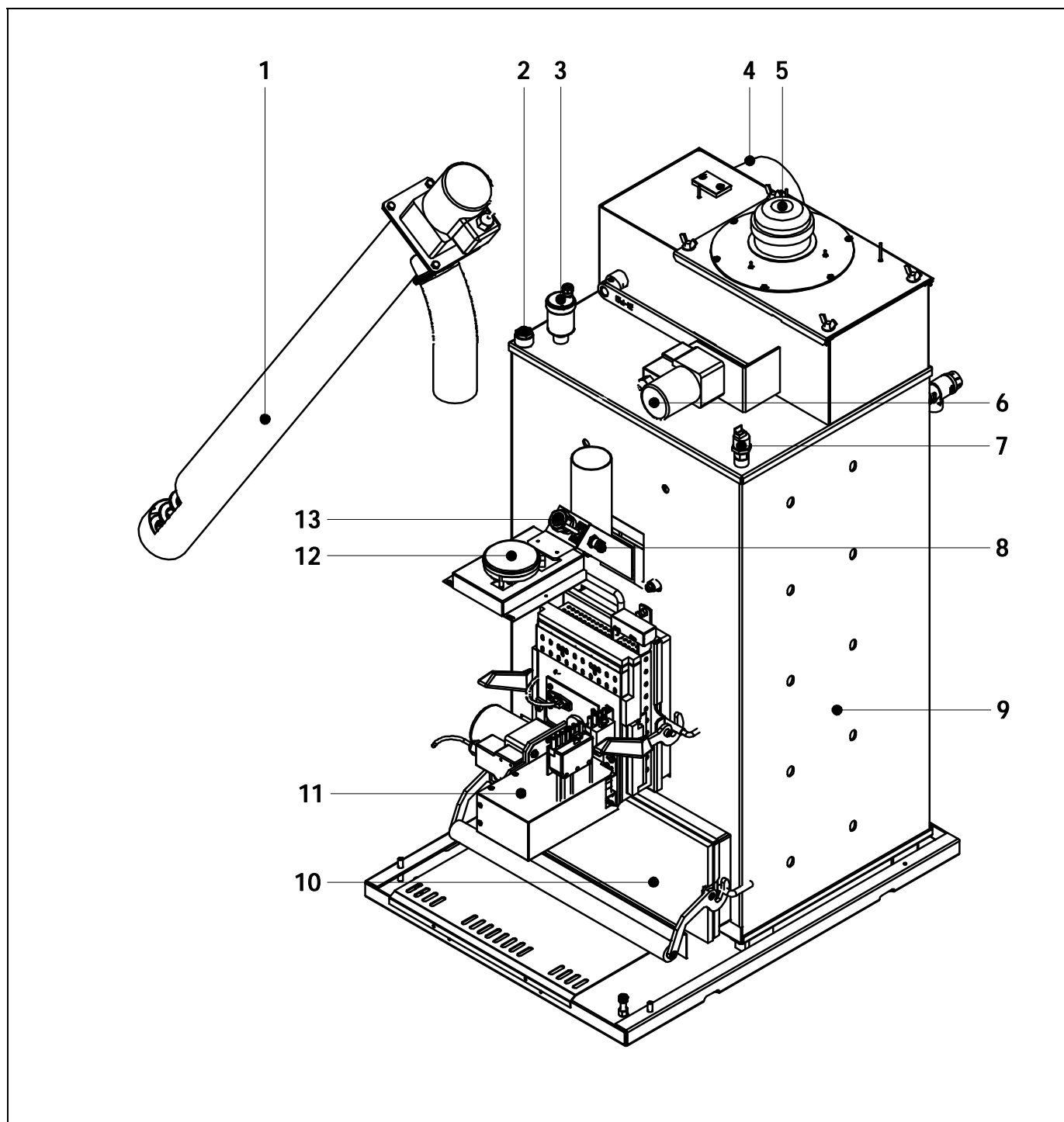

- | | |
|------------------------------------|-------------------------------------|
| 1. Feed auger. | 8. Fuel entrance safety thermostat. |
| 2. Sensor housing. | 9. Heat exchanger. |
| 3. Automatic Air vent. | 10. Ash drawer. |
| 4. Flue outlet | 11. Burner. |
| 5. Fan. | 12. Air pressure sensor. |
| 6. Heat exchanger cleaning system. | 13. Peephole. |
| 7. Water pressure sensor. | |

2 CONTROL COMPONENTS

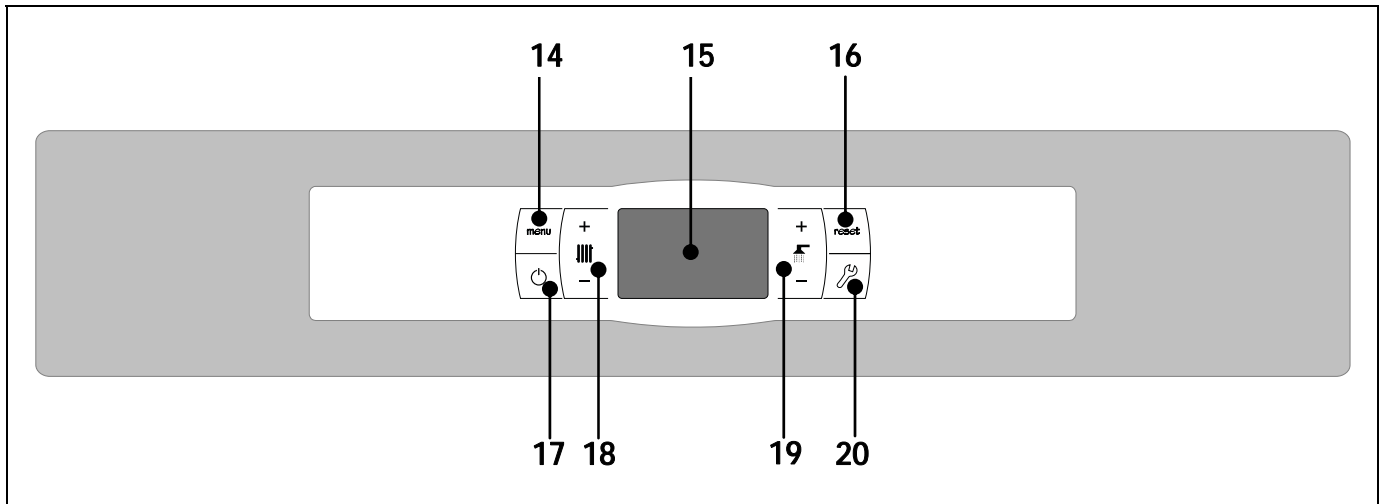

14. MENU touch button:

This button is used to access and browse through the "User Menu".

15. Digital display:

It is the main boiler functioning display, on which all the operating information, settings and values appear. This display is also used to access the appliance's user and service settings. In standard operating mode (default display), the actual boiler temperature is shown. If malfunction occurs, an alarm code will appear on the digital display instead of the temperature.

16. RESET touch button:

This button is used to restore functioning of the boiler after a lock-out situation. Also it is used to exit from any of the menus or parameters of the boiler without saving it and to return to the previous menu level.

17. ON touch button:

This button switches on and off the boiler.

18. Boiler temperature touch button:

This button is used to select the boiler set point temperature. It is also used to disable the hot water function.

19. DHW temperature touch button:

This button is used to select the desired domestic hot water set point temperature (only if a DHW tank is connected to the boiler). It is also used to disable the DHW function.

20. SET touch button:

This button is used to access and browse through the "Setup menu". Touch this button to access the settings options.

3 INSTALLATION INSTRUCTIONS

The boiler must be installed by personnel authorised by the Ministry of Industry, in compliance with the applicable laws and regulations.

This boiler is suitable for heating water to a temperature below boiling point at atmospheric pressure. It must be connected to a heating installation and/or a domestic hot water distribution network, which must always be compatible with its performance and power.

This appliance must only be used for the purpose for which it has been expressly designed. Any other use is considered unsuitable and therefore hazardous. The manufacturer shall not be considered liable under any circumstances for damage caused by unsuitable, erroneous or irrational use.

Remove all the packaging and check the contents are complete. In case of doubt, do not use the boiler. Contact your supplier. Keep the packaging elements out of reach of children, as they can be dangerous.

When you no longer wish to use the boiler, disable the parts that could be a potential source of hazard.

3.1 Location

The boiler must be installed in a sufficiently ventilated site, away from humidity. It must be located so that the air grilles on the premises are not obstructed and normal boiler maintenance is possible even if it is placed between items of furniture. One metre of free space must be left above the boiler for this purpose.

3.2 Hydraulic installation

The hydraulic installation must be made by qualified personnel. The applicable installation legislation is to be complied with, and the following recommendations should also be taken into account:

- The inside of the installation piping should be thoroughly cleaned before switching on the boiler.
- We recommend inserting cut-off valves between the installation piping and the boiler to simplify maintenance tasks.
- Leave a free space around the boiler for carrying out any maintenance and repair operations.
- Drain valves and suitable devices for correctly bleeding the air from the circuit during the boiler filling stage should be fitted.
- Install all the necessary safety elements (expansion vessel, safety valve, etc.) to comply with the applicable regulations for the installation.
- If the boiler is installed at a lower height than the heating installation, it is recommendable to create a siphon at the boiler outlet, to prevent the installation from heating up due to natural convection when heating is not required.

BioClass HM

3.3 Installing a Sanit hot water tank (Optional)

For a correct electrical connection of a Sanit DHW hot water tank with **BioClass HM** boiler, these steps should be followed:

- **Unplug the boiler from the mains power.**
- Connect a DHW temperature sensor (supplied optionally) to the sensor terminal strip **J7 (Sa; terminals 16 and 17)** (see "*Connections Diagram*").
- Insert the temperature sensor bulb in the bulb-holder sheath provided on the hot water tank.
- Connect the 3-way DHW diverter valve or the hot water tank booster pump (depending on the installation, modify parameter **P.09**) to the supply terminal strip **J3 (BA; terminals 6 and N)** (see "*Connections Diagram*").

The hydraulic installation for the 3-way DHW diverter valve should be made so that the heating circuit can flow through the valve when it is in rest position (not energised):

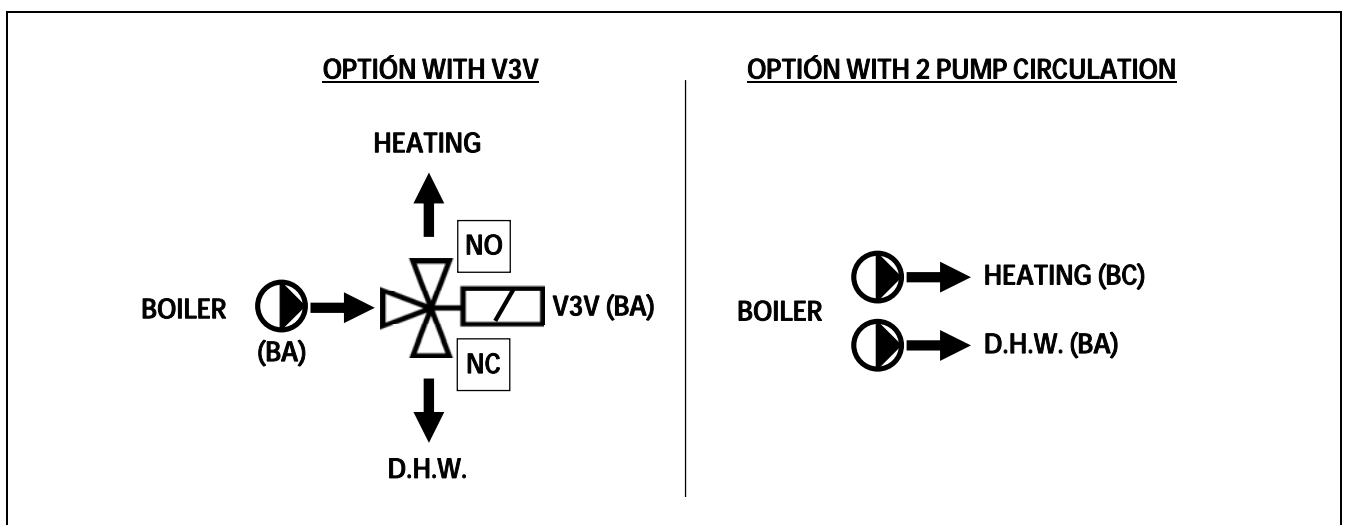

For correct hydraulic installation of the hot water tank, carefully follow the assembly and connection instructions enclosed with the same.

3.4 Fuel

BioClass HM boiler must be fuelled by **DIN PLUS** certified wood pellet. The **DIN PLUS** certificate assures that the fuel's humidity levels and calorific value are ideal for optimum boiler functioning. If this requirement is not complied with, **DOMUSA TEKNIK's** guarantee of the appliance will automatically be null and void.

The following points should be taken into account for correct fuel storage:

- The stored pellets should be kept dry all year round.
- The applicable legislation in each country for correct fuel storage must be complied with.

3.5 Installing the hopper

DOMUSA TEKNIK supplies a hopper for storing the pellets with the boiler. The tank is reversible and can be mounted on either the left or right side of the boiler. It is also equipped with adjustable feet for height regulation.

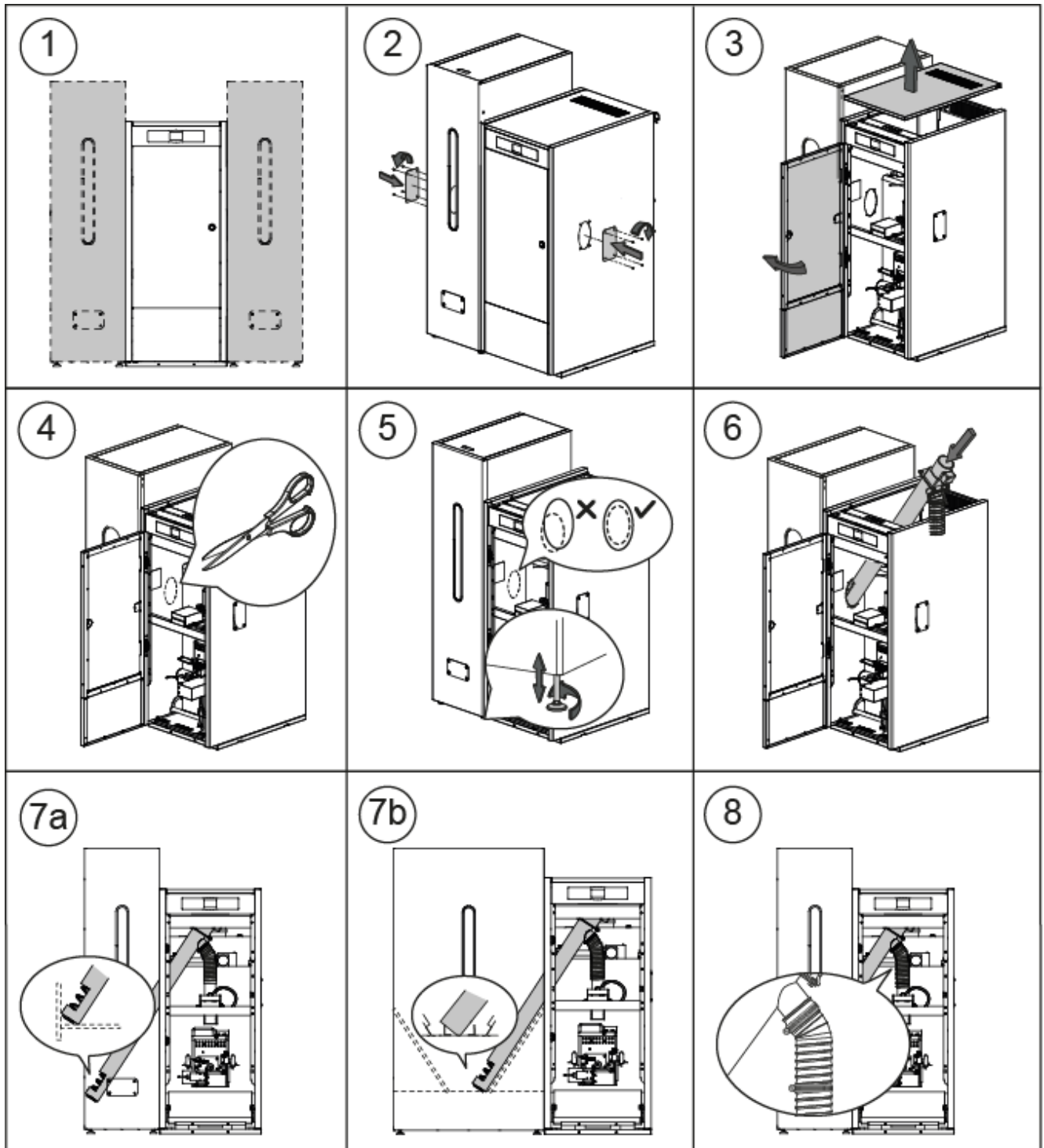

IMPORTANT: Ensure the height of the elliptical holes on the sides of the boiler and on the hopper coincide, for correct insertion of the feed auger. To do this, make the necessary adjustments for height (using the adjustment feet) and depth (correctly positioning the hopper).

BioClass HM

3.6 Electrical Connection

The boiler is equipped for connection at 230 V~, 50 Hz. **The socket should have an appropriate earth connection.**

The boiler has a strip **TA₁ (J6)**, prepared for connecting a room thermostat or room chronothermostat (see *Electrical Connection Diagram*) for remote control of the heating circuit. To correctly connect the room thermostat, remove the bridge joining the terminals on the strip **TA₁**.

The terminal strip **J2** includes terminals for connecting the feed auger, whereas the terminal strip **J3** includes terminals for connecting the circulation pump of the boiler (**BC**) and the 3-way diverter valve (or circulation pump) for the optional DHW circuit. The terminal strip **J7** includes terminals for connecting a sensor for the optional DHW circuit. This sensor must be supplied by **DOMUSA TEKNIK**.

IMPORTANT: Before carrying out any work on the boiler's electrical installation, always ensure it is disconnected from the mains.

3.7 Combustion product removal

BioClass HM boiler is a biomass boiler and it is essential for it to be connected to a flue, i.e. a smoke duct able to create a pressure drop (which in this case should be between 0.10 and 0.20 mbar), in compliance with the applicable laws to this regard.

The combustion product exhaustion ducts must be installed by qualified personnel and must comply with the regulations in force. For the flue to create a pressure drop, the following recommendations should be taken into account:

- It should be suitably insulated.
- It should be independently located, with a separate flue for each boiler.
- It should be vertical, avoiding any angles greater than 45°.
- It should always have the same diameter. It is recommendable for it to be circular, and never any narrower than the boiler outlet.
- **It is obligatory to install a fume inspection plate with condensation collection, to remove the condensation generated in the flue.** Otherwise, the condensation may reach the inside of the boiler and cause irreparable damage, **which would not be covered by DOMUSA TEKNIK's guarantee. The condensation pipe should lead to a drain outlet**, as a large amount of water may be generated. This connection must be made in compliance with the regulations for draining off condensation water to the drain network.
- **It is recommended to install a draught stabiliser** to prevent any pressure drop variations in the flue due to atmospheric conditions, which could affect correct boiler combustion. **This draught stabiliser must be installed below the fume inspection plate to prevent any leakage of combustion gases.**

3.8 BIO hydraulic kit installation

In option a **BIO hydraulic kit**, within the kits range offered by **DOMUSA TEKNIK**, could be connected to **BioClass HM** boiler. In that way the features of the boiler will be increased.

Look at the following instructions for a correct installation:

- **Unplug the boiler and the hydraulic kit from the main power supply.**
- Connect the communication between the boiler and BIO hydraulic kit. Use the cable of two wires with two connectors (+A –B) supplied with the kit (documentation bag). **To assure the correct running of BIO hydraulic Kit it is essential to respect the polarity of the connection. The same wire must be connected to the +A terminal of the boiler as well as to the +A terminal of the hydraulic Kit. Same operation with the –B terminals as it is shown in the picture below.**
- After connecting the communication between the boiler and the hydraulic Kit, plug the **BIO hydraulic Kit** to the main power supply. It is recommended to plug the Kit before the boiler to assure a correct running of the system.
- Plug the boiler to the main power supply.

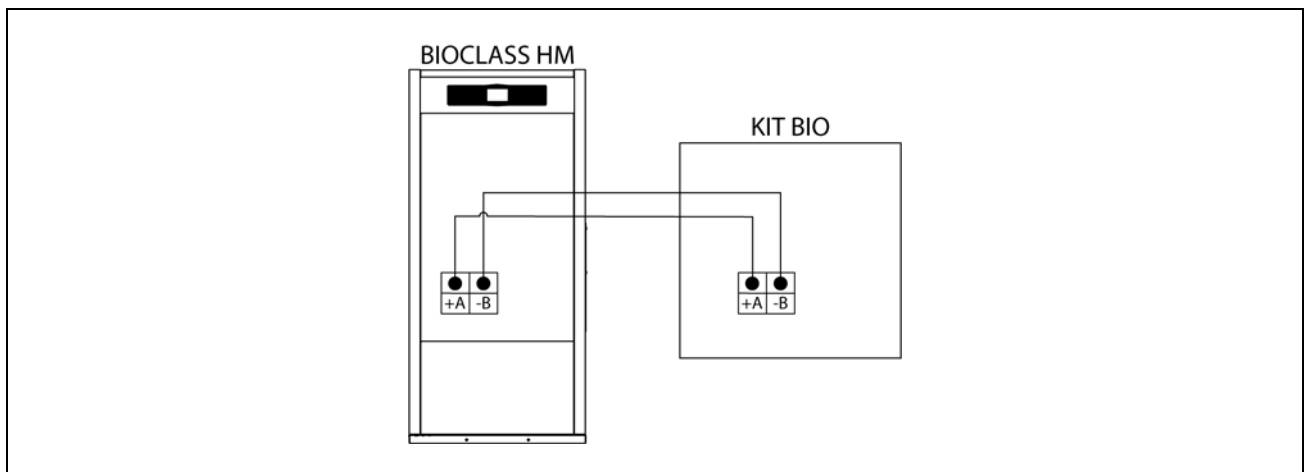

Follow the instructions provided with the kit to assure a correct installation.

IMPORTANT: It is compulsory to respect the polarity of both wires of the cable to assure a correct running of BIO hydraulic Kit.

NOTE: It is recommended to plug the kit before the boiler to assure a correct running.

BioClass HM

3.9 Installation with a BT Buffer Tank (Optional)

The **BioClass HM** boiler can be accompanied by a **BT Buffer Tank** during the installation from the wide range offered by DOMUSA TEKNIK, which may increase the benefits provided by the boiler in the heating service.

For this reason, the electronic control of the boiler is equipped with an input for a temperature sensor or a temperature thermostat (**Sbt**; terminals 18-19 on connection strip **J7**) and a circulation pump output (**Bbt**; terminals N-7 on the connection strip **J2**) dedicated exclusively to managing the heating of the buffer tank. Using these control elements of the boiler you will be able to manage 4 different modes of buffer tank hydraulic installation. The installation type will be selected using parameter **P.08** in the "Technician" menu on the control panel.

The boiler is supplied with this installation option disabled. To enable it, the electrical resistance (**Rbt**) connected between terminals **18** and **19** of connection strip **J7** (see "Connection Diagram") must be disconnected and replaced with a temperature sensor (supplied as an option by DOMUSA TEKNIK) or a control thermostat installed in the BT buffer tank. After disconnecting the resistance in the "Technician" menu of the control panel, parameter **P.08** must be enabled, via which you can select the installation mode desired.

The following sections describe in detail the hydraulic and electrical connection characteristics for each installation mode.

3.9.1 Installation with Sanit DHW tank after BT tank and control by temperature sensor (P.08 = 1)

In this installation mode, all heating circuits, as well as the circuit for producing DHW by accumulation, if present, must be hydraulically connected to the BT buffer tank. In other words, as shown in the following hydraulic diagram, the BT buffer tank is connected to the boiler, interposing a circulation pump (**Bbt**), and all the heating circuits of the system are connected to the BT tank. The temperature of the BT tank is controlled and managed by a temperature sensor (**Sbt**) immersed in the buffer tank and electrically connected to the boiler. The temperature sensor is optionally supplied by DOMUSA TEKNIK.

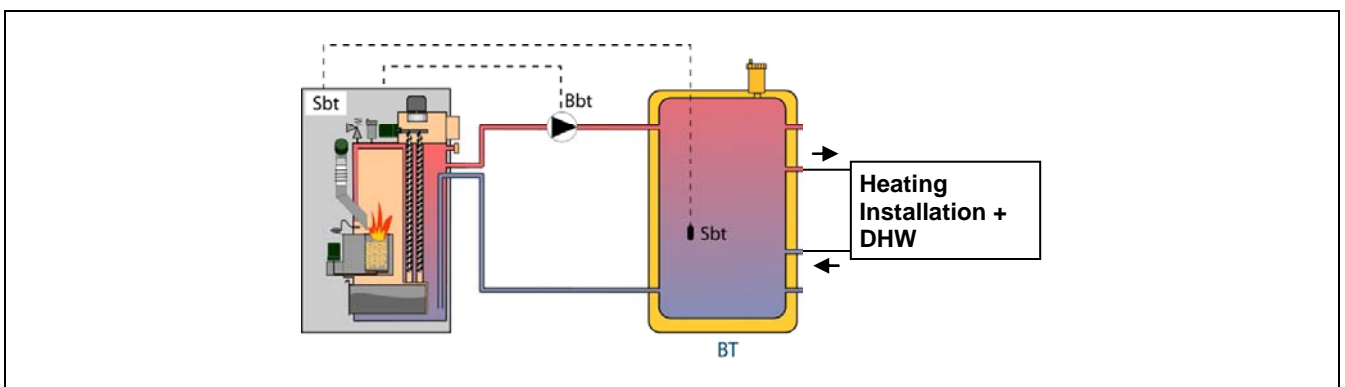

After the hydraulic installation of all the system components, proceed as follows to carry out the correct electrical connection of the BT buffer tank to the **BioClass HM** boiler:

- **Unplug the boiler from the mains power.**
- Disconnect the electrical resistance (**Rbt**) connected between terminals **18** and **19** of connection strip **J7** (see "Connection Diagram").
- Connect the BT tank temperature sensor (supplied optionally) to the sensor connection strip **J7** (**Sbt**; terminals **18** and **19**) (see "Connection Diagram").
- Insert the temperature sensor bulb in the bulb-holder sheath provided in the buffer tank.

- Connect the BT tank feed pump to the component connection strip **J2 (Bbt; terminals N and 7)** (see "Connection Diagram").
- Connect the boiler to the mains power.
- Using the control panel, access parameter **P.08** in the "Technician" menu (see "Technician Menu") and set the value to "1".
- After that, if it is necessary, set also the parameter **P.28** "BT buffer tank temperature hysteresis".

Once the hydraulic and electrical connection described above has been completed, to adjust and configure the BT buffer tank operation, carefully read the section "Operation with a BT buffer tank" in this manual.

3.9.2 Installation with Sanit DHW tank before BT tank and control by temperature sensor (P.08 = 2)

In this installation mode, all heating circuits must be hydraulically connected to the BT buffer tank, and the circuit for producing DHW by accumulation should be hydraulically connected to the boiler, upstream from the BT buffer tank. In other words, the BT buffer tank and the Sanit DHW tank, if present, are connected in parallel to the boiler. Depending on the type of installation of the DHW tank (installation with DHW diverter valve or with a DHW pump), the BT tank feed pump (**Bbt**) will be installed as indicated in the following hydraulic diagrams. The temperature of the BT tank is controlled and managed by a temperature sensor (**Sbt**) immersed in the buffer tank and electrically connected to the boiler. The temperature sensor is optionally supplied by DOMUSA TEKNIK.

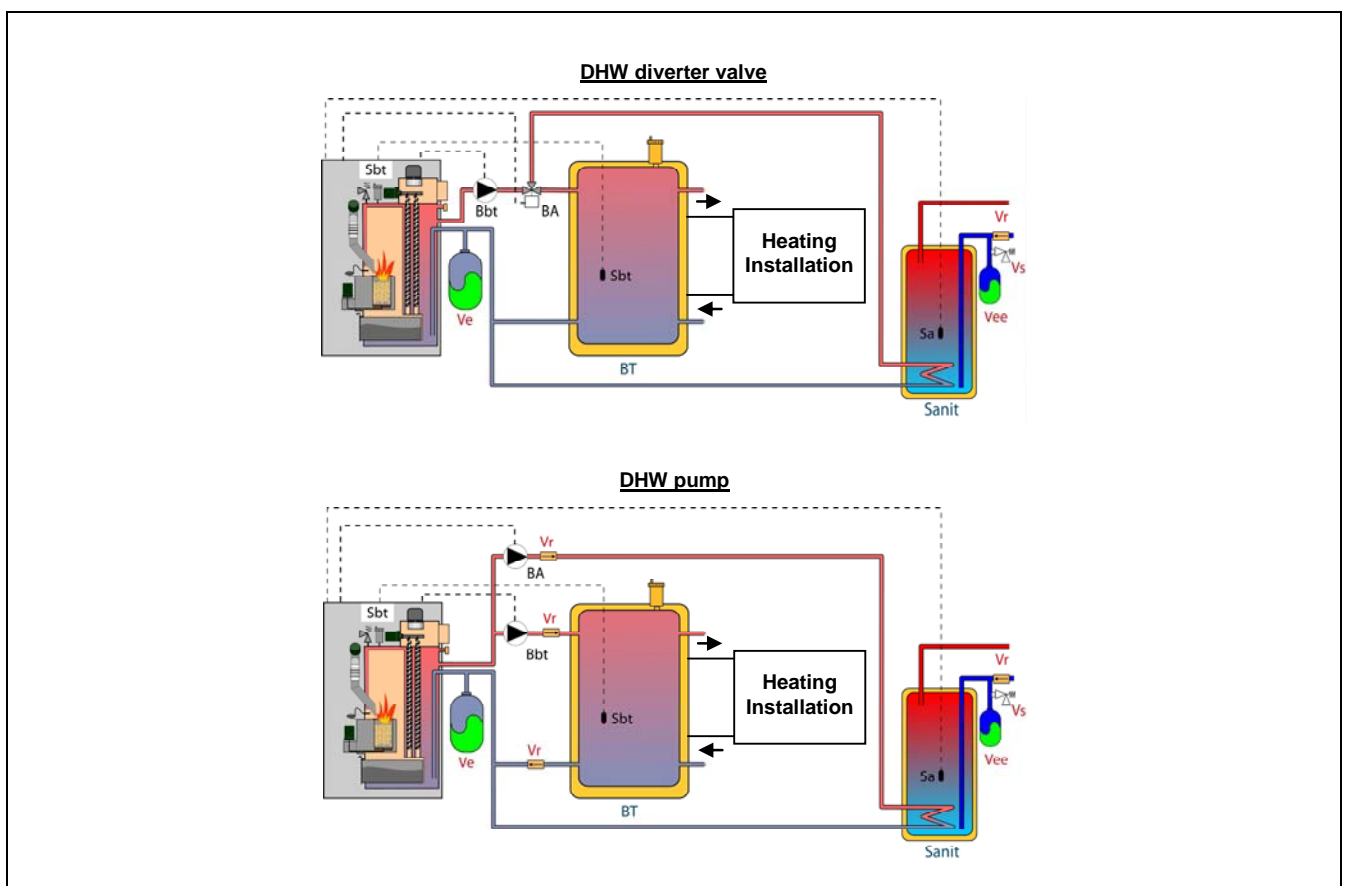

After the hydraulic installation of all the system components, proceed as follows to carry out the correct electrical connection of the BT buffer tank to the **BioClass HM** boiler:

- **Unplug the boiler from the mains power.**
- Disconnect the electrical resistance (**Rbt**) connected between terminals **18** and **19** of connection strip **J7** (see "Connection Diagram").

BioClass HM

- Connect the BT tank temperature sensor (supplied optionally) to the sensor connection strip **J7 (Sbt; terminals 18 and 19)** (see "Connection Diagram").
- Insert the temperature sensor bulb in the bulb-holder sheath provided in the buffer tank.
- Connect the BT tank feed pump to the component connection strip **J2 (Bbt; terminals N and 7)** (see "Connection Diagram").
- Connect the boiler to the mains power.
- Using the control panel, access parameter **P.08** in the "Technician" menu (see "Technician Menu") and set the value to "2".
- After that, if it is necessary, set also the parameter **P.28** "BT buffer tank temperature hysteresis".

For the correct hydraulic and electrical installation of a Sanit DHW tank with a **BioClass HM** boiler, carefully follow the directions in the section "Installing a Sanit tank" in this manual.

Once the hydraulic and electrical connection described above has been completed, to adjust and configure the BT buffer tank operation, carefully read the section "Operation with a BT buffer tank" in this manual.

3.9.3 Installation with Sanit DHW tank after BT tank and control by thermostat (P.08 = 3)

In this installation mode, all heating circuits, as well as the circuit for producing DHW by accumulation, if present, must be hydraulically connected to the BT buffer tank. In other words, as shown in the following hydraulic diagram, the BT buffer tank is connected to the boiler, interposing a circulation pump (**Bbt**), and all the heating circuits of the system are connected to the BT tank. The temperature of the BT tank is controlled and managed by a thermostat (**Tbt**) installed and immersed in the buffer tank and electrically connected to the boiler. The temperature control thermostat is not supplied by DOMUSA TEKNIK but can be purchased at any specialist central heating supplies warehouse.

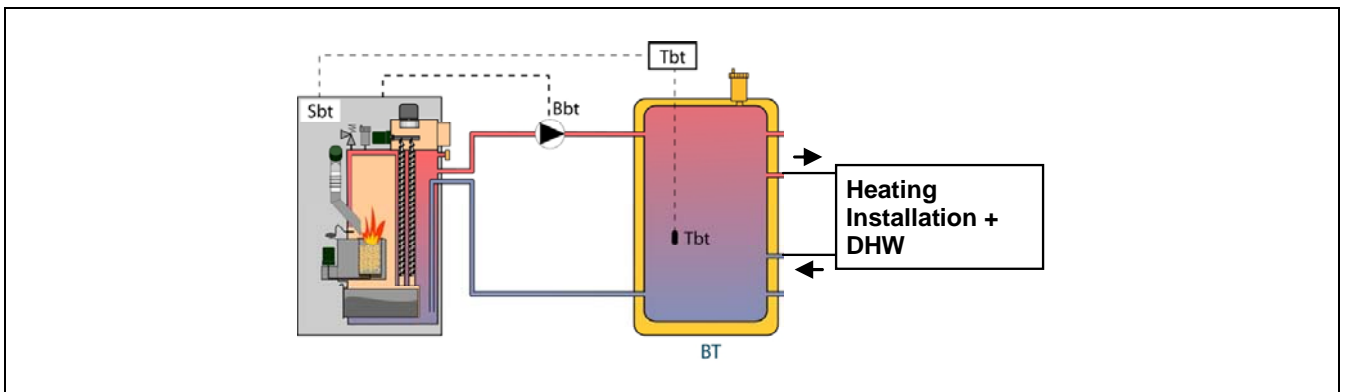

After the hydraulic installation of all the system components, proceed as follows to carry out the correct electrical connection of the BT buffer tank to the **BioClass HM** boiler:

- **Unplug the boiler from the mains power.**
- Disconnect the electrical resistance (**Rbt**) connected between terminals **18** and **19** of connection strip **J7** (see "Connection Diagram").
- Connect the **NC** contact (normally closed) on the BT tank control thermostat on the sensor connection strip **J7 (Sbt; terminals 18 and 19)** (see "Connection Diagram").
- Insert the thermostat bulb into the bulb-holder sheath provided in the buffer tank.
- Connect the BT tank feed pump to the component connection strip **J2 (Bbt; terminals N and 7)** (see "Connection Diagram").
- Connect the boiler to the mains power.

- Using the control panel, access parameter **P.08** in the "Technician" menu (see "Technician Menu") and set the value to "3".

Once the hydraulic and electrical connection described above has been completed, to adjust and configure the BT buffer tank operation, carefully read the section "Operation with a BT buffer tank" in this manual.

3.9.4 Installation with Sanit DHW tank before BT tank and control by thermostat (P.08 = 4)

In this installation mode, all heating circuits must be hydraulically connected to the BT buffer tank, and the circuit for producing DHW by accumulation should be hydraulically connected to the boiler, upstream from the BT buffer tank. In other words, the BT buffer tank and the Sanit DHW tank, if present, are connected in parallel to the boiler. Depending on the type of installation of the DHW tank (installation with DHW diverter valve or with a DHW feed pump), the BT tank feed pump (**Bbt**) will be installed as indicated in the following hydraulic diagrams. The temperature of the BT tank is controlled and managed by a thermostat (**Tbt**) installed and immersed in the buffer tank and electrically connected to the boiler. The temperature control thermostat is not supplied by DOMUSA TEKNIK but can be purchased at any specialist central heating supplies warehouse.

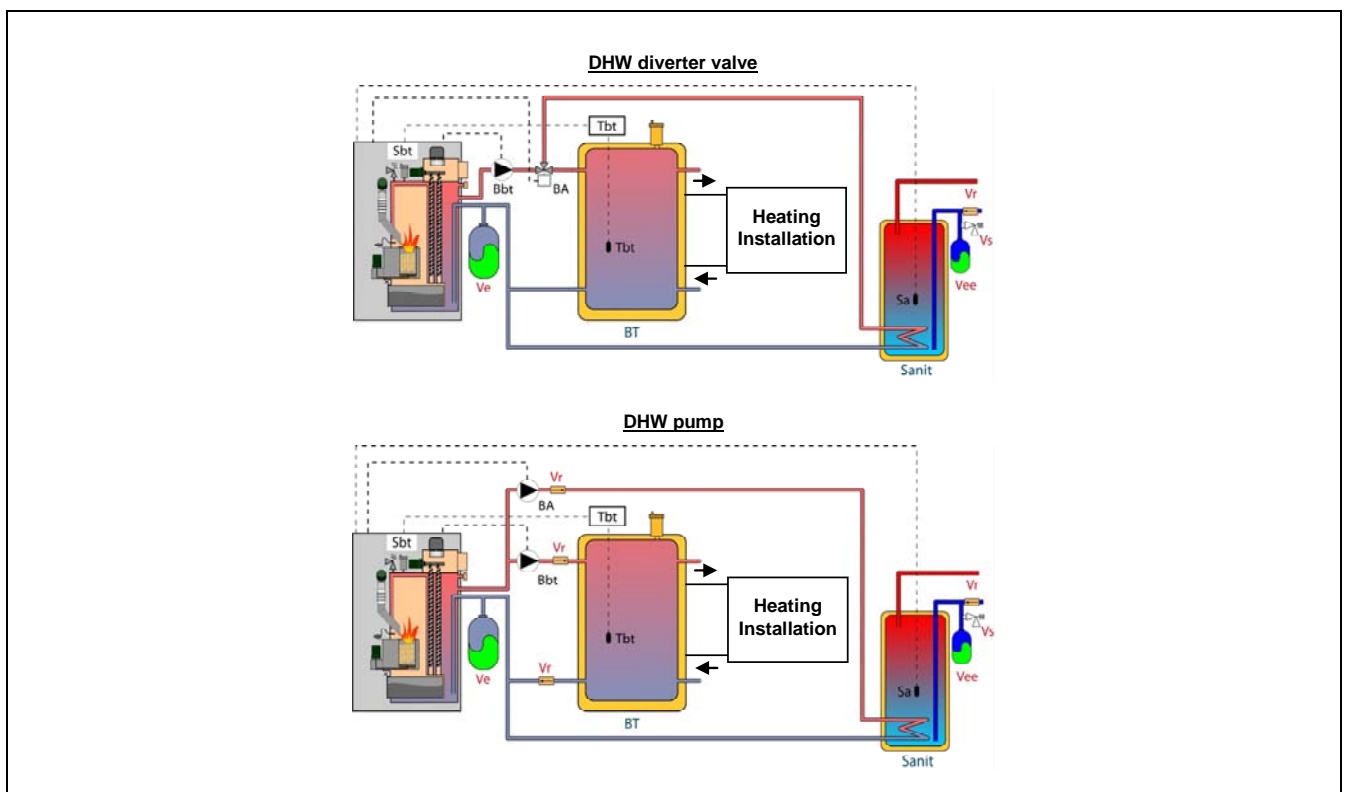

After the hydraulic installation of all the system components, proceed as follows to carry out the correct electrical connection of the BT buffer tank to the **BioClass HM** boiler:

- **Unplug the boiler from the mains power.**
- Disconnect the electrical resistance (**Rbt**) connected between terminals **18** and **19** of connection strip **J7** (see "Connection Diagram").
- Connect the **NC** contact (normally closed) on the BT tank control thermostat on the sensor connection strip **J7** (**Sbt**; terminals **18** and **19**) (see "Connection Diagram").
- Insert the thermostat bulb into the bulb-holder sheath provided in the buffer tank.
- Connect the BT tank feed pump to the component connection strip **J2** (**Bbt**; terminals **N** and **7**) (see "Connection Diagram").
- Connect the boiler to the mains power.

BioClass HM

- Using the control panel, access parameter **P.08** in the "Technician" menu (see "Technician Menu") and set the value to "4".

For the correct hydraulic and electrical installation of a Sanit DHW tank with a **BioClass HM** boiler, carefully follow the directions in the section "Installing a Sanit tank" in this manual.

Once the hydraulic and electrical connection described above has been completed, to adjust and configure the BT buffer tank operation, carefully read the section "Operation with a BT buffer tank" in this manual.

3.10 Installation with a BT-DUO buffer tank (Optional)

The **BioClass HM** boiler can be accompanied by a **BT-DUO Buffer Tank** during the installation from the wide range offered by DOMUSA TEKNIK, which may increase the benefits provided by the boiler in the heating service. This tank has a hot water storage tank inside, thereby adding the provision of DHW in addition to the buffer tank functionality. For this reason, its connection to the boiler as well as its operating configuration are specific.

For this reason the electronic control of the boiler is equipped with an input for connecting the primary control thermostat **Tcp** of the BT-DUO tank (input **Sbt**; terminals 18-19 on connection strip **J7**) and a circulation pump output (**Bbt**; terminals N-7 on the connection strip **J2**) dedicated exclusively to managing the heating of the buffer tank. Also, for correctly managing the DHW production in the tank integrated in the BT-DUO tank, a DHW temperature sensor (supplied optionally) must be included in the installation.

The boiler is supplied with this installation option disabled. To enable it, the electrical resistance (**Rbt**) connected between terminals **18** and **19** of connection strip **J7** (see "Connection Diagram") must be disconnected and replaced with a temperature sensor (supplied as an option by DOMUSA TEKNIK) or a control thermostat installed in the BT buffer tank. After disconnecting the resistance in the "Technician" menu of the control panel, parameter **P.08** must be enabled, via which you can select the installation mode and appropriate functioning for this type of buffer tank.

The BT-DUO buffer tank is hydraulically connected to the boiler, interposing a circulation pump (**Bbt**), and all the central heating circuits of the system are connected to the BT-DUO tank. For the correct hydraulic installation of the **BT-DUO** tank and the feed pump **Bbt**, carefully follow the instructions in the following hydraulic diagram:

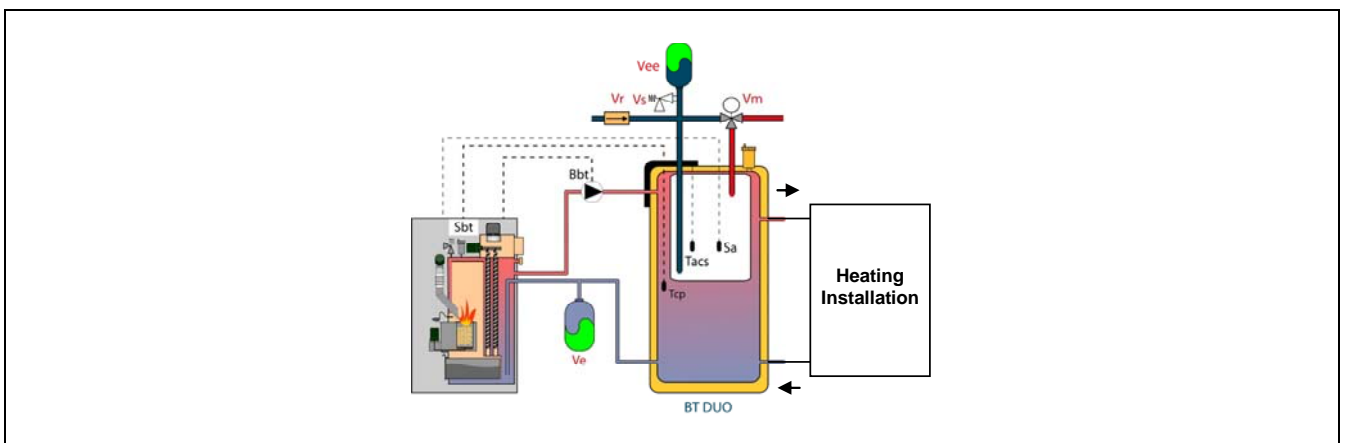

After the hydraulic installation of all the system components, proceed as follows to carry out the correct electrical connection of the BT-DUO buffer tank to the **BioClass HM** boiler:

- **Unplug the boiler from the mains power.**
- Disconnect the electrical resistance (**Rbt**) connected between terminals **18** and **19** of connection strip **J7** (see "Connection Diagram").

- Using a 2-wire electrical hose connect the **TAcald** terminals (terminals **7** and **8** in the wiring diagram of the BT-DUO tank manual) of the BT-DUO tank control thermostat (**Tcp**) to the sensor connection strip **J7 (Sbt; terminals 18 and 19)** (see "*Connection Diagram*").
- Connect the DHW temperature sensor (supplied optionally) to the sensor connection strip **J7 (Sa; terminals 16 and 17)** (see "*Connection Diagram*"), previously removing the resistance **Ra**, supplied as standard with the boiler.
- Insert the DHW temperature sensor bulb into the bulb-holder sheath provided in the DHW tank of the BT-DUO buffer tank.
- Connect the BT-DUO tank feed pump to the component connection strip **J2 (Bbt; terminals N and 7)** (see "*Connection Diagram*").
- Connect the boiler to the mains power.
- To correctly configure the type of installation you must adjust parameters **P.08** y **P.09** in the "Technician" menu on the control panel. Access parameter **P.08** in the "Technician" menu (see "*Technician Menu*") and set the value to "**4**". Next, access parameter **P.09** from the same menu and set the value to "**0**".

For the correct hydraulic and electrical installation of a **BT-DUO** buffer tank, carefully follow the instructions in the manual supplied with it.

Once the hydraulic and electrical connection described above has been completed, to adjust and configure the BT-DUO buffer tank operation, carefully read the section "*Operation with a BT-DUO buffer tank*" in this manual.

4 COMMISSIONING OF THE BOILER

4.1 Prior warnings

Repair and maintenance of the boiler must be carried out by a qualified professional, authorised by **DOMUSA TEKNIK**. For optimum functioning and conservation of the boiler, it should be serviced annually.

Carefully read this instruction manual and keep it in a safe, easily-accessible place. **DOMUSA TEKNIK** will not be liable for any damages caused by failure to follow these instructions.

Before any servicing, **disconnect the boiler from the mains**.

4.2 Electrical Connection

BioClass HM boiler is supplied with a mains connection plug.

4.3 Filling the installation

The hydraulic installation must include a fill valve, drain valves and the necessary hydraulic components for correctly filling the installation.

To fill the installation, open the fill valve until the parameter "*Water pressure*" of "*User Menu*" shows a pressure of 1 - 1.5 bars. The installation must be filled slowly, bleeding the air from the water circuit using the drain valves provided on the same. Close the fill valve after filling.

BioClass HM boilers have a pressure sensor for controlling the pressure of the installation. If the installation does not have the minimum pressure set at **P.19** parameter of "*Technical Menu*" (by default 0.5 bar), a low pressure alarm will appear ("**E-19**").

IMPORTANT: Switching on the boiler with no water inside could result in serious damage.

4.4 Initial calibration of the feed auger

BioClass HM boiler is equipped with a feed auger to supply the fuel. Follow the instructions described in "*Installing the hopper*" section to install it correctly. Due to diversity of feed augers and the range of different hoppers, it is needed to calibrate the feed auger minimum twice to assure the correct running.

During the commissioning, after filling the installation, ("**E-25**") alarm code is displayed. It isn't possible to switch on the boiler before calibrating the feed auger. Follow the instructions described in "*Feed auger calibration*" section of "*Setup menu*" to assure a correct calibration. Once the calibration is finished, "**E-25**") alarm would disappear and it will be possible to switch on the boiler.

4.5 Commissioning

In order for the **guarantee to be valid**, the boiler must be commissioned by **personnel authorised by DOMUSA TEKNIK**. Before beginning the commissioning, the following must be complied with:

- The boiler must be plugged in to the mains.
- The installation must be filled with water (the pressure must be between 1 and 1.5 bar).
- The hopper must be filled with fuel.

The commissioning sequence is as follows:

- Check the flue is correctly installed using a condensation inspection tap and a draught stabiliser.
- Check the hopper and the feed auger are correctly installed. **The feed auger must be calibrated for a correct boiler functioning** (See *"Calibrating the feed auger"*). Check the right type of fuel is being used (wood pellet must be **DIN PLUS**).
- If the installation has flow and return valves, check they are open.

4.6 Installation delivery

After commissioning, the Technical Assistance Service will explain to the user how the boiler functions, making any observations they consider relevant.

The installer is responsible for clearly explaining to the user the functioning of any control or regulation device forming part of the installation but not supplied with the boiler.

BioClass HM

5 DIGITAL DISPLAY

BioClass HM boiler is equipped with a digital touch display for viewing and adjustment of the different boiler settings. The display has various display areas where different icons and numbers appear to indicate the different status of the boiler.

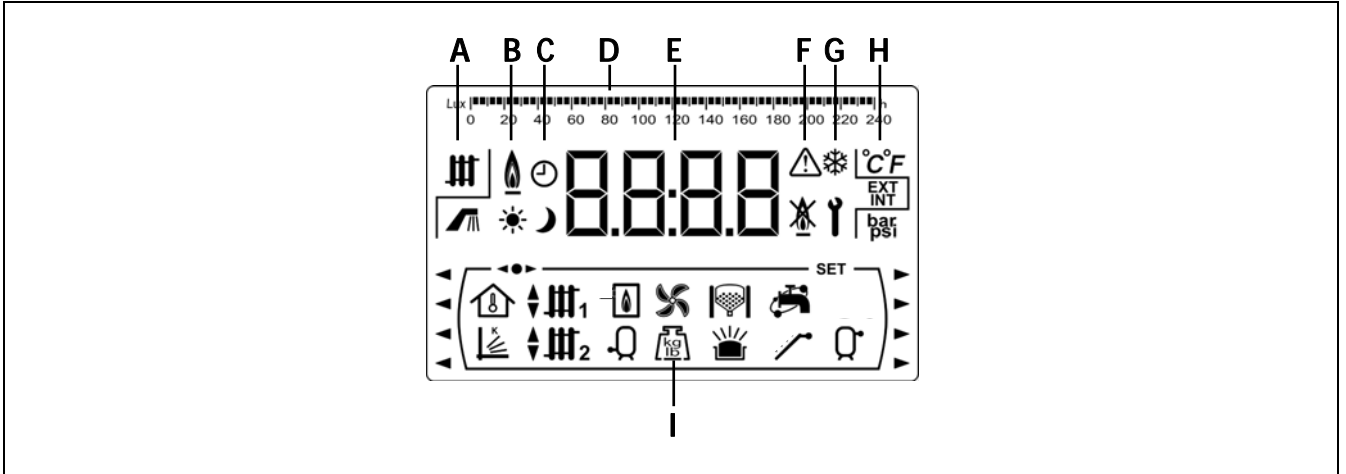

A Boiler status: Heating function enabled.
DHW production enabled.

B Icon for flame detection: Flame detected.

C Timer icons:

It is displayed when the real time is inside "ON" programmed period.

It is displayed when actual time is inside "OFF" programmed period.

When any screen is displayed it relates to the display of actual time, programming, etc.

D Scale marking bar: The meaning can change depending on the parameter displayed:

Time scale: Used to indicate values or settings related to the time and/or time programming:



Lux scale: Used to indicate the lux level read by the flame sensor:



Ash Scale: Used to indicate the level of ash:





E Numerical digits.

F Alarm icons: Warning.

Boiler lock-out.

G Special functions icons:

 **Anti-frost function:** This icon blinks when the boiler's anti-frost function is activated.

 **Technical icon:** It is displayed when any of the boiler's technical parameter on the "Technical Menu" or "Setup menu" is displaying or modifying.

H Auxiliary icons.

 Value or setting related to a temperature is shown by the numerical digits.

EXT Value or setting related to the outside temperature is shown by the numerical digits.

INT Value or setting related to the room temperature are shown by the numerical digits.

bar Value or setting related to the boiler water pressure is shown by the numerical digits.

I Operating mode icons:

 It is displayed when a value or setting related to the room temperature or room thermostat or remote controls is shown by the numerical digits.

 It is displayed when a value or setting related to OTC operating mode is shown by the numerical digits.

 It is displayed when the direct heating circuit n° 1 demand is activated or when a value or setting related to this circuit is shown by the numerical digits.

 It is displayed when the direct heating circuit n° 2 demand is activated or when a value or setting related to this circuit is shown by the numerical digits.

 It is displayed when the mixing heating circuit n° 1 demand is activated or when a value or setting related to this circuit is shown by the numerical digits. The arrows appear according to the 3 way mixing valve of the circuit activation mode. The upper arrow indicates that the hot channel of the valve is opening, and the lower arrow indicates that the hot channel of the valve is closing.

 It is displayed when the mixing heating circuit n° 2 demand is activated or when a value or setting related to this circuit is shown by the numerical digits. The arrows appear according to the 3 way mixing valve of the circuit activation mode. The upper arrow indicates that the hot channel of the valve is opening, and the lower arrow indicates that the hot channel of the valve is closing.







 It is displayed when any value or setting related to the boiler and/or the burner is shown by the numerical digits.

 It is displayed when a value or setting related to DHW tank is shown by the numerical digits.

 It is displayed when a value or setting related to boiler's fan is shown by the numerical digits.

 It is displayed when a value or setting related to weight, calibration, fuel consumption, etc. is shown by the numerical digits.

BioClass HM

-  It is displayed when a value or setting related to the **CVS Suction System** is shown by the numerical digits.
-  It is displayed when a value or setting related to the burner's ash cleaning system or boiler's ashtray (either manual or compressor) is shown by the numerical digits.
-  It is displayed when a value or setting related to the ashtray overflowing is shown by the numerical digits.
-  It is displayed when a value or setting related to DHW recirculation function is shown by the numerical digits. It displays blinking when the DHW recirculation pump is switched on.
-  It is displayed when the feed auger is switched on and it is displayed blinking when it is in manual operation mode.
-  Display of any value or parameter related to the temperature or operation of the buffer tank.
-  It is displayed when any of the *"Menu"* is in browse mode.
- SET** It is displayed when the parameter shown by the numerical digits is adjustable and it is displayed blinking when the parameter is in adjustment mode.

6 OPERATION

BioClass HM is set by default as an "Only Heating" boiler. In option, it is possible to connect a DHW tank and/or a **BIO Hydraulic Kit** to increase the features offered.

6.1 "Only heating" operation

In this operation mode, it is needed to set a temperature of the boiler (see "*Boiler temperature set point selection*"), of the room thermostat (**TA1**) or of the **LAGO FB OT+** remote control (if there is any connected) in order to start the boiler up. The burner will start running to heat the water of the boiler. When the temperature of the boiler overtakes 60 °C, the heating pump is switched on to heat the water of the installation. The burner modulates the heat output level to maintain the set point temperature selected and the pump continues running until the installation reaches to the temperature selected in the room thermostat or remote control (if there is any connected). When the temperature in the boiler overtakes 4 °C the boiler set point temperature the burner stops until the temperature decreases 10 °C behind the set point temperature, in this moment the burner is switched on again.

It is possible to disable the heating service (*Summer* mode) by setting to "**oFF**" the boiler temperature set point. In this operating mode only the DHW service is available if there is a DHW tank installed.

NOTE: When the heating service is disabled, they will be disabled all the circuits of the **BIO Hydraulic Kit**, if there is any connected.

6.2 Operating with a Sanit DHW tank (Option)

BioClass HM boiler could be installed together with a DHW tank **Sanit**, within the product range offered by **DOMUSA TEKNIK**, to obtain Domestic Hot Water service. Follow the instructions described in section "*Installing a Sanit hot water tank*" to assure a correct installation.

In this operating mode, it is needed to set a DHW temperature set point (see "*DHW temperature set point selection*") in order to start DHW service up. The burner will start running and the DHW pump or valve will switch on if the boiler's temperature overtakes 60 °C and it is higher than the one into DHW tank. When DHW tank temperature reaches the set point temperature, after a poscirculation period of time (parameter **P.16** of "Technical Menu"), the boiler will be able to heat the heating installation by switching on the heating pump. The burner modulates the heat output level to maintain the boiler temperature set point. The heating pump will stop when the room temperature reaches the set point set at the room thermostat or remote control (if there is any connected).

It is possible to disable the DHW by setting to "**oFF**" the DHW temperature set point.

NOTE: To assure the optimal DHW service, the heating service will not be available while the DHW service is activated to heat the DHW tank.

BioClass HM

6.3 Boiler temperature set point selection

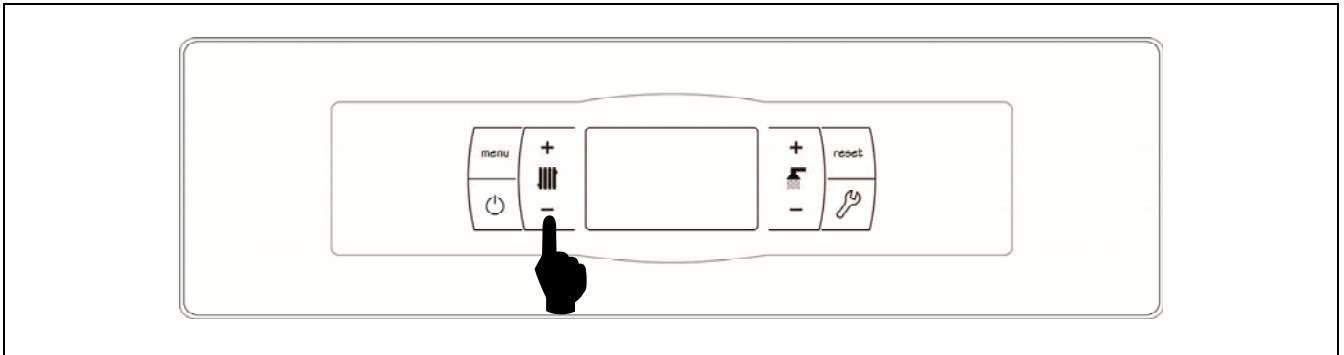

Boiler temperature set point selection is made by the tactile selector shown in the picture. Press "+" and "-" buttons to increase or decrease the set point desired. Few seconds after the desired set point temperature is adjusted the display returns to main position. The range of values for boiler temperature set point is OFF, 65 - 80 °C.

It is also possible to set boiler temperature set point browsing through the "User Menu" by pressing **MENU** button. When parameter "Boiler set point temperature" is displayed, the boiler temperature set point is set by pressing "+" and "-" buttons.

When the "OTC operating mode" is activated by means of **P.10** parameter of "Technical Menu" and the K-factor is set for the heating circuit of the boiler (or direct heating circuit of **BIO Hydraulic Kit**), the boiler temperature set point is calculated depending on the K-factor selected. The boiler temperature set point parameter only allows to set between activating ("on") or deactivating ("off") the heating service.

It is possible to disable the heating service of the boiler (**Summer** mode) by setting to "off" the boiler temperature set point by pressing "-" symbol for heating (**18**).

6.4 DHW temperature set point selection (with DHW tank installed only)

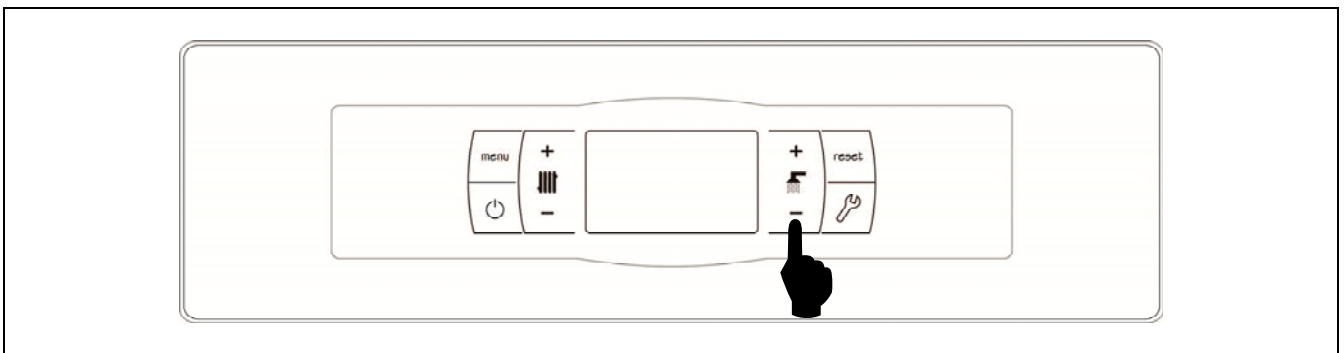

DHW temperature set point selection is made by the tactile selector shown in the picture. Press "+" and "-" buttons to increase or decrease the set point desired. Few seconds after the desired set point temperature is adjusted the display returns to main position. The range of values for DHW temperature set point is OFF, 15 - 65 °C.

It is also possible to set the DHW temperature set point browsing through the "User Menu" by pressing **MENU** button. When parameter "DHW temperature set point" is displayed, the DHW temperature set point is set by pressing "+" and "-" buttons.

It is possible to disable the DHW service by setting to "off" the DHW temperature set point by pressing "-" for DHW (**19**).

6.5 Selecting the setpoint temperature of the buffer tank (only with buffer tank)

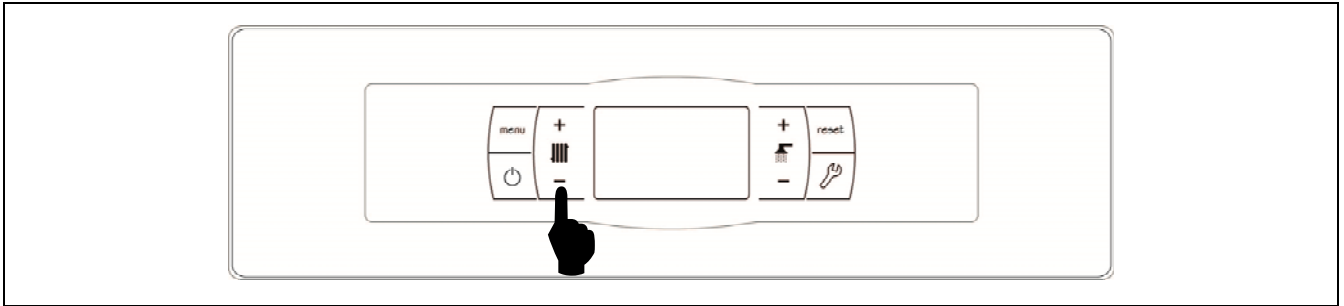

The desired buffer tank temperature is selected using the touch button, as shown in the figure. To select the desired temperature, touch the "+" or "-" symbols to increase or decrease the temperature. When the temperature has been selected, the display will return to standby mode after a few seconds. The permitted range of setpoint temperature is OFF, 30 - 80 °C.

The buffer tank setpoint temperature can also be selected by using the touch button MENU to browse to the display option "*Buffer tank setpoint temperature*". When this option appears on the display, touch the "+" or "-" symbols to select the desired temperature.

If you wish to totally disable the central heating function of the installation (**Summer** mode), select the setpoint value "**oFF**", by touching the "-" symbol until this value appears on the display.

6.6 Functioning according to Outdoor Temperature Conditions OTC (option)

When the boiler is installed together with a **BIO Hydraulic Kit** and an outdoor temperature sensor AFS is connected in the Kit, the OTC operation mode could be activated by means of **P.10** parameter at the "*Technical Menu*".

When this operation mode is activated, the boiler and/or heating flow temperature are automatically adjusted in accordance with the K-factor curve set at the "*Technical Menu*" (parameters **P.11** and **P.12**) and the outdoor temperature measured by the outdoor sensor. If the installation is correctly dimensioned, the boiler temperature and/or flow temperature calculated will ensure the room temperature set point set at room thermostat or remote control (if there is any connected).

The K-factor curve relates the outdoor temperature, measured by the sensor installed outside the building, with the boiler temperature set point. The diagram shows the temperature value for each point on the K-factor curve.

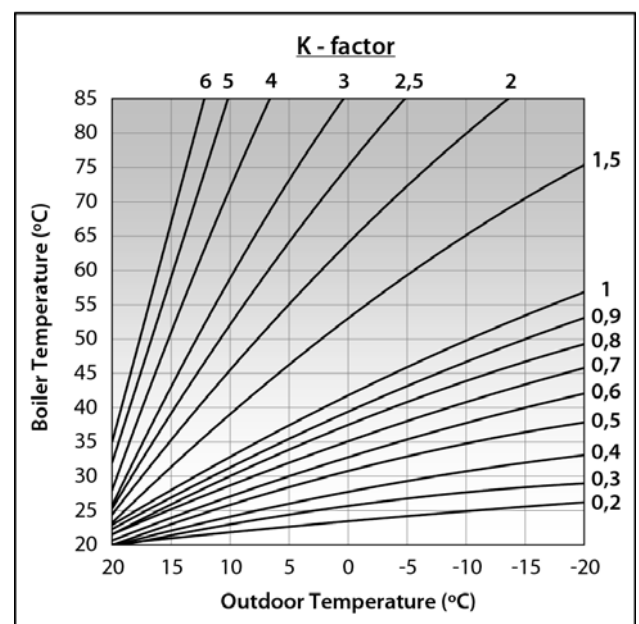

Depending on the type of heating circuit, isolation of the building and position of the outdoor sensor, the optimal K-factor curve could be different. Nevertheless, a general rule could be that for high temperature heating circuits (radiators heating circuit) the K-factor curve should be 1 or higher and for low temperature heating circuits (underfloor heating circuit) it should be 0.8 or less.

IMPORTANT: To connect the outdoor sensor AFS to BIO Hydraulic Kit, follow the connection instructions provided within the Kit.

7 OPERATING WITH BIO HYDRAULIC KITS (OPTIONAL)

All the models within **BioClass HM** range of boilers may be installed together with a **BIO Hydraulic Kit** to regulate more than one heating circuit. Up to 3 heating circuits and a DHW circuit can be managed depending on the **BIO Hydraulic Kit** chosen. For a detailed description of the functioning of the Kit, read the manual supplied within the Kit. Nevertheless the following guidelines are given:

Direct circuit functioning (P.23)

When the **BIO Hydraulic Kit** installed has a direct circuit pump (**Bcd**), by means of parameter **P.23** of the *“Technical Menu”* its operation mode may be selected:

P.23 = 0 => Operating as a heating pump (by default).

P.23 = 1 => Operating as a DHW charging pump.

When the direct circuit pump is configured for heating circuit operation mode (**P.23 = 0**) it will work with the selected boiler temperature set point and the temperature of the room thermostat **TA1** or a LAGO FB OT+ remote control, both connected to the terminal strip of the boiler (see *“Connections diagram”*). When the **BIO Hydraulic Kit** is operating with an outdoor temperature sensor, by means of parameter **P.10** OTC operation mode (Outdoor Temperature Control) may be selected for the direct circuit. OTC mode allows the boiler temperature setting depending on the K-factor curve set at **P.11** or **P.12** parameter and the actual outdoor temperature read by the sensor.

When the direct circuit pump is configured as a DHW tank charging pump (**P.23 = 1**), the direct circuit will work according to the DHW temperature set point selected on the boiler main board and the temperature read by the DHW sensor **Sa** installed into the tank.

In both cases, the burner and circulating pump will start operating (**Bcd** of the **BIO Hydraulic Kit**) until the temperature set point is reached in the boiler or in the DHW storage tank.

Mixing circuit n° 1 functioning

The mixing heating circuit No 1 will work together with the flow temperature set point adjusted for circuit No 1 and the temperature of the room thermostat or LAGO FB OT+ remote control connected in the **BIO Hydraulic Kit** (see *“Connection diagram”* of the BIO Hydraulic Kit instructions manual). When the **BIO Hydraulic Kit** is operating with an outdoor temperature sensor, by means of parameter **P.10** OTC operation mode (Outdoor Temperature Control) may be selected for the direct circuit. OTC mode allows the boiler temperature setting depending on the K-factor curve set at **P.11** parameter and the actual outdoor temperature read by the sensor.

Mixing circuit n° 2 functioning

The mixing heating circuit No 2 will work together with the flow temperature set point adjusted for circuit No 2 and the temperature of the room thermostat or LAGO FB OT+ remote control connected in the **BIO Hydraulic Kit** (see *“Connection diagram”* of the BIO Hydraulic Kit instructions manual). When the **BIO Hydraulic Kit** is operating with an outdoor temperature sensor, by means of parameter **P.10** OTC operation mode (Outdoor Temperature Control) may be selected for the direct circuit. OTC mode allows the boiler temperature setting depending on the K-factor curve set at **P.12** parameter and the actual outdoor temperature read by the sensor.

8 OPERATION WITH A BT BUFFER TANK (OPTIONAL)

The **BioClass HM** boiler can be accompanied by a **BT Buffer tank** from the wide range of tanks offered by **DOMUSA TEKNIK**. This tank accumulates heat energy that improves the performance of the system when switching the boiler on and off. For its correct installation, carefully follow the assembly instructions included with the tank and for its correct integration with the **BioClass HM** boiler, read the instructions in the section "*Installing a BT Buffer tank*" in this manual.

The electronic control of the **BioClass HM** boiler is able to manage four different installation configurations of the BT buffer tank. Depending on the configuration of the installation (parameter **P.08** in the "Technician" menu) there are 2 operating modes:

8.1 Operation with a temperature sensor in the BT buffer tank (P.08 = 1 or 2)

In this operating mode you must select the desired setpoint temperature of the buffer tank (*see "Selecting the buffer tank setpoint temperature"*) and the temperature of the the room thermostat No. 1 (**TA1**) or remote control **LAGO FB OT+** (if present). The burner will start working to heat the water in the boiler. When the boiler temperature exceeds 60 °C the feed pump for the buffer tank (**Bbt**) will start up to heat the BT tank. The modulating burner of the **BioClass HM** boiler will keep the water in the buffer tank at the set temperature. When the temperature of the tank reaches the selected set point temperature the burner will shut down until its temperature drops to the value set in parameter **P.28** (by default 5 °C) below that desired, once again starting a new heating cycle.

Regarding the central heating service of the boiler, the circulation pump (**BC**) will be activated whenever room thermostat No. 1 (**TA1**), or the remote control **LAGO FB OT+** (if present), demands heating. In other words, when the room temperature where the thermostat or the remote control is installed is lower than that which is set. When the atmosphere reaches the desired temperature and after a time of post-circulation (parameter **P.15** in the "Technician Menu"), the operation of the heating pump (**BC**) will turn off.

The boiler's central heating service can be totally disabled (*Summer* mode) by selecting a buffer tank setpoint value of "**OFF**". In this operating mode, only the DHW production function will remain enabled, providing there is a DHW tank connected to the tank (**P.08 = 1**) or to the boiler (**P.08 = 2**).

NOTE: When the heating function is disabled, all the circuits of the BIO hydraulic Kit will also be disabled, if connected.

NOTE: This operating mode is only activated when parameter P.08 of the "Technician" menu is set to 1 or 2 and when there is a buffer tank installed.

BioClass HM

8.2 Operation with a control thermostat in the BT buffer tank (P.08 = 3 or 4)

In this operating mode you must select the desired setpoint temperature of the boiler (*see "Selecting the boiler setpoint temperature"*) and, using the control thermostat installed in the buffer tank, you must also select the desired setpoint temperature in the buffer tank. **It is essential for the operation of the installation that the setpoint temperature selected for the boiler exceeds the setpoint selected for the control thermostat of the buffer tank and it is recommended that it be at least 5 to 10 °C higher.** The modulating burner of the **BioClass HM** boiler will start working to heat the water within it. When the boiler temperature exceeds 60 °C the feed pump for the buffer tank (**Bbt**) will start up to heat the BT tank, provided that its control thermostat is activated (demanding heating). When the buffer tank thermostat reaches the desired temperature and turns off the heating demand, operation of the buffer tank feed pump (**Bbt**) will be disabled.

Regarding the central heating service of the boiler, the circulation pump (**BC**) will be activated whenever room thermostat No. 1 (**TA1**), or the remote control **LAGO FB OT+** (if present), demands heating. In other words, when the room temperature where the thermostat or the remote control is installed is lower than that which is set. When the atmosphere reaches the desired temperature and after a time of post-circulation (parameter **P.15** in the "Technician Menu"), the operation of the heating pump (**BC**) will turn off.

The boiler's central heating service can be totally disabled (*Summer* mode) by selecting a boiler setpoint value of "**oFF**". In this operating mode, only the DHW production function will remain enabled, providing there is a DHW tank connected to the tank (**P.08 = 3**) or to the boiler (**P.08 = 4**).

IMPORTANT: It is essential for the operation of the installation that the setpoint temperature of the boiler exceeds the setpoint selected for the control thermostat of the buffer tank.

NOTE: When the heating function is disabled, all the circuits of the BIO hydraulic Kit will also be disabled, if connected.

NOTE: This operating mode is only activated when parameter P.08 of the "Technician" menu is set to 3 or 4 and when there is a buffer tank installed.

9 OPERATION WITH A BT-DUO BUFFER TANK (OPTIONAL)

The **BioClass HM** boiler can be accompanied by a **BT-DUO Buffer tank** from the wide range of tanks offered by **DOMUSA TEKNIK**. This tank accumulates heat energy that improves the performance of the system when switching the boiler on and off. It also incorporates a DHW cylinder in its interior for obtaining Domestic Hot Water. For its correct installation, carefully follow the assembly instructions included with the tank and for its correct integration with the **BioClass HM** boiler, read the instructions in the section "*Installing a BT-DUO Buffer tank*" in this manual.

In this operating mode you must select the desired setpoint temperature of the boiler (*see "Selecting the boiler setpoint temperature"*) and, using the adjustment thermostat of the control panel in the BT-DUO buffer tank, you must also select the desired setpoint temperature in the buffer tank. **It is essential for the operation of the installation that the setpoint temperature selected for the boiler exceeds the setpoint selected for the thermostat of the BT-DUO buffer tank and it is recommended that it be at least 5 to 10 °C higher.** The modulating burner of the **BioClass HM** boiler will start working to heat the water within it. When the boiler temperature exceeds 60 °C the feed pump for the buffer tank will start up to heat the BT-DUO tank, provided that its control thermostat is activated (demanding heating). When the BT-DUO tank thermostat reaches the desired temperature and turns off the heating demand, the operation of its feed pump will be disabled.

Regarding the central heating service of the boiler, the circulation pump connected to it (**BC**) will be activated whenever room thermostat No. 1 (**TA1**), or the remote control **LAGO FB OT+** (if present), demands heating. In other words, when the room temperature where the thermostat or the remote control is installed is lower than that which is set. When the atmosphere reaches the desired temperature and after a time of post-circulation (parameter **P.15** in the "Technician Menu"), the operation of the heating pump (**BC**) will turn off.

Regarding the operation of the service for providing DHW, provided that a DHW temperature sensor is installed in the **BT-DUO** tank, you must select the desired DHW setpoint temperature (*see "Selecting the DHW setpoint temperature"*). The burner will ignite and the feed pump for the **BT-DUO** tank will be activated whenever the water temperature of the boiler exceeds 60 °C. When the tank reaches the DHW setpoint temperature selected and after a waiting period (parameter **P.16** in the "Technician Menu"), it will once again be available to heat the central heating system, activating the central heating service. In order to provide an optimal production of DHW, while this is active the boiler's central heating service will remain disabled and it will not be restored until it has finished heating the DHW cylinder of the **BT DUO** tank.

The boiler's central heating service can be totally disabled (*Summer* mode) by selecting a boiler setpoint value of "**oFF**". In this operating mode, only the DHW production function will remain enabled, via the cylinder integrated inside the **BT-DUO** tank. Also, you may totally disable the domestic hot water production function by selecting "**oFF**" as the DHW setpoint temperature.

IMPORTANT: It is essential that the setpoint temperature of the boiler exceeds the setpoint selected for the control thermostat of the buffer tank.

NOTE: When the heating function is disabled, all the circuits of the BIO hydraulic Kit will also be disabled, if connected.

NOTE: For the correct operation of the BT-DUO buffer tank, parameters P.08 and P.09 in the "Technician" menu must be set to 4 and 0 respectively.

10 OPERATING WITH LAGO FB OT+ REMOTE CONTROL (OPTIONAL)

A remote control (**LAGO FB OT+**) can optionally be supplied together with **BioClass HM** boiler. This remote control can be used to fully operate the boiler from anywhere in the room in which it is installed. The **LAGO FB OT+** remote control regulates the parameters of heating circuit and the domestic hot water production.

This remote control allows the hours of comfort to be programmed for heating circuit, regulating the installation to the particular requirements of the building by measuring the room temperature and consequently adapting the installation temperature. The remote control can also be used to regulate the hot water and heating temperatures set point at any time, and for viewing the different boiler operation parameters. It also warns of any functioning anomalies affecting the boiler.

The **LAGO FB OT+** remote control may optionally be connected to an outdoor temperature sensor, for measuring the temperature around the building. With this option installed, the remote control can adjust the building comfort level according to the weather conditions, optimising fuel consumption and heating comfort in the building.

The **LAGO FB OT+** remote control takes over the control of the boiler when it is connected. The different selectable temperatures boiler of the boiler must be set at the remote control. It is easy to install, requiring only 2 wires for communication between the boiler and the **LAGO FB OT+** control, by connecting the two wires on terminal strip **J5** (see *"Electrical Connection Diagram"*). For a correct installation and functioning, read carefully the instructions within the remote control.

The following sections contain a general explanation of the different operating modes and options of **LAGO FB OT+** remote control.

Operation of the heating circuit

The maximum temperature for heating circuit, the operating period of time and the desired room temperature can be set at remote control. **LAGO FB OT+** remote control will calculate the boiler temperature required at each particular time, depending on the temperature of the room and it will activate or deactivate the heating demand depending on the heating times and room temperatures programmed.

DHW service function

When **BioClass HM** boiler is installed together with a DHW tank the desired DHW temperature and the desired periods of time for DHW service must to be set at **LAGO FB OT+** remote control. **LAGO FB OT+** remote control regulates the DHW tank temperature and enables or disables the DHW service according to the time periods scheduled.

11 USER MENU

"User Menu" shows the settings related to boiler functioning on the digital display.

To access this menu press MENU; press this button repeatedly to browse through the different settings available. When one of the options is displayed, after 20 seconds the display returns to main position. In the following table are listed all the settings of "User Menu":

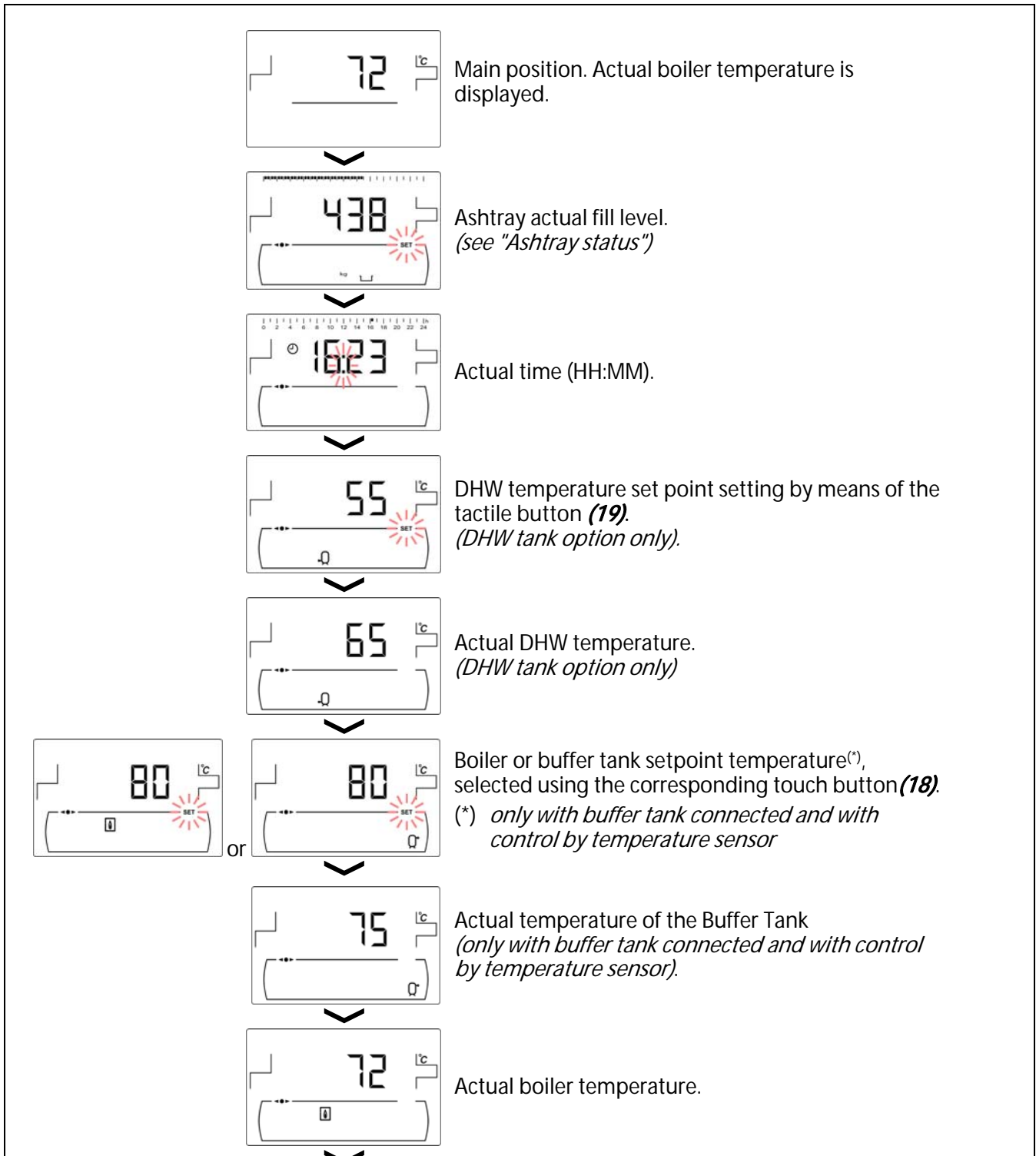

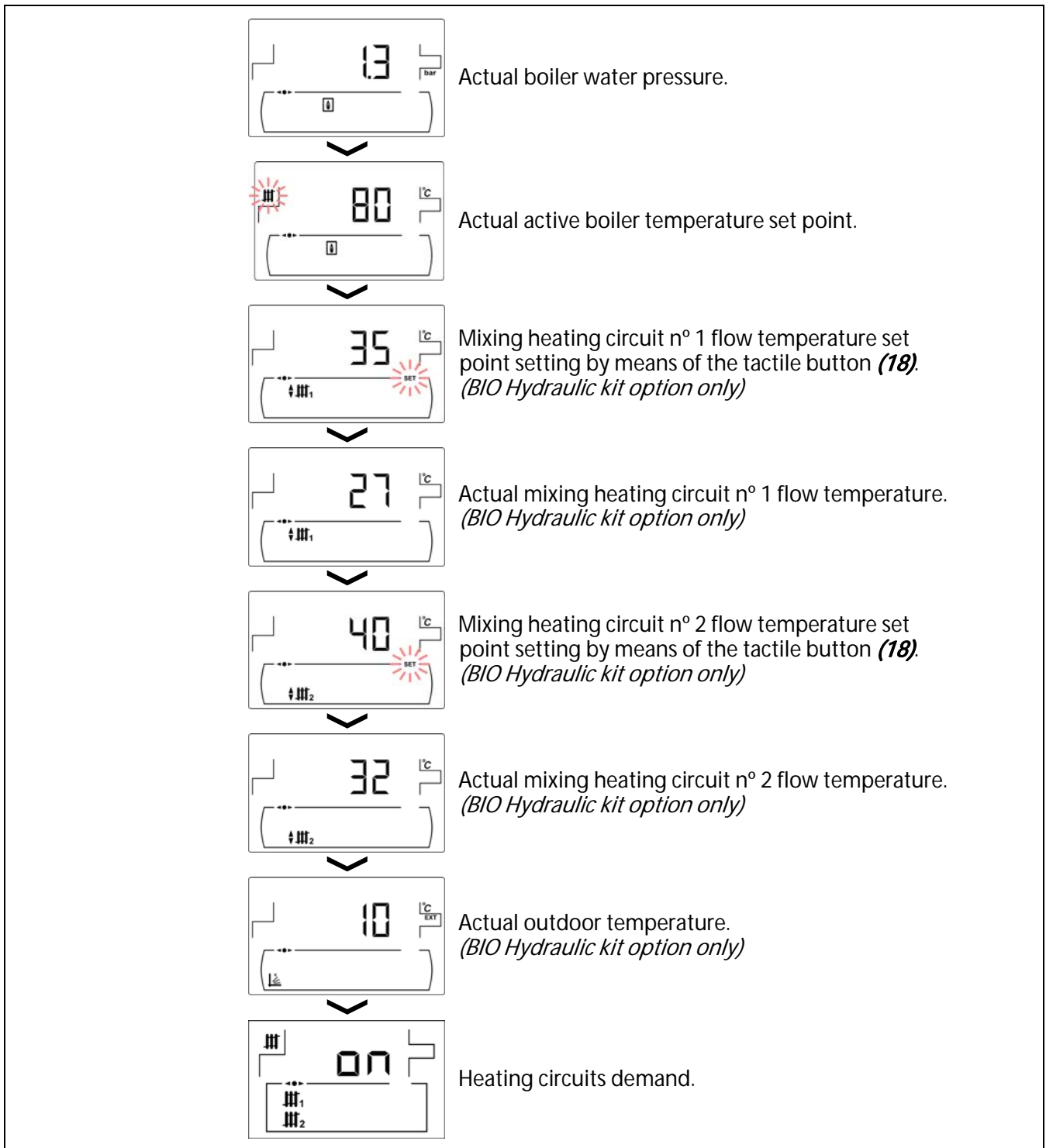

11.1 Ashtray status

When "Ashtray Empty Warning" function is activated (see "Setup menu"), the boiler warns about the ashtray is full and must be emptied. The parameter "Ashtray status" allows checking the fill level and the screen shows the ash scale bar which indicates the fill level of the ashtray. When it is full, an "Empty the ashtray" warning is activated. Whenever the ashtray is emptied, it is necessary to set the "Ashtray status" parameter to "0" by pressing "-" for DHW **(19)**.

The display of the notices is as follows:

- : Ashtray fill level between 0 and 75 %.
- : flashing: Ashtray fill level between 75 and 100 %.
- and : flashing: Ashtray fill level more than 100 %.

12 SETUP MENU

"Setup menu" consists of operating parameters of the boiler which can be adjusted by the user (Ashtray empty warning, timer programming, time setting, ...)

To access to the "Setup menu" press . Browse through the menu by pressing the symbols "+" or "-" of heating (18). When a parameter is displayed, press to access and set it. When the parameter has been set, press again, the new value will be saved and the display will return to "Setup menu". Press RESET any time to go back without recording any value. In the following table are listed all the parameters of "Setup menu".

Nº.	Parameter	Display
1	Boiler timer programming.	
2	CVS Suction System timer programming. <i>(CVS Suction System option only)</i>	
3	DHW recirculation function timer programming. <i>(DHW tank option only)</i>	
4	Time setting.	
5	Ashtray empty warning function.	
6	Manual setting of feed auger calibration.	
7	Screen contrast setting.	

BioClass HM

12.1 Timers programming process

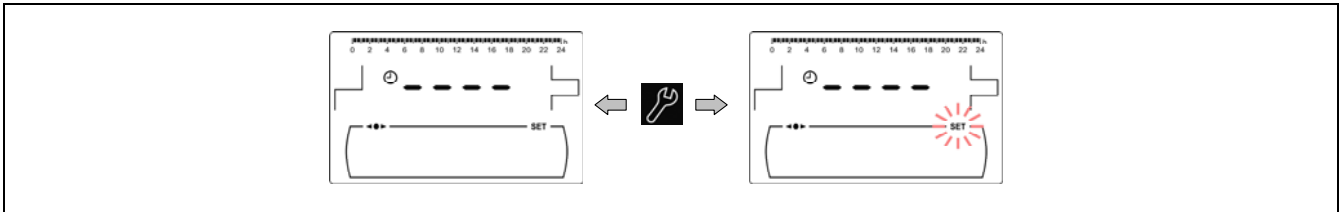

BioClass HM boiler allows setting 3 different timers: boiler timer, **CVS Suction System** timer (if there is any connected) and DHW recirculation pump timer (if this function is activated on the "Technical Menu"). The default setting for the timers is disabled ("- - -"), so the functioning that is regulated by each timer will operate 24 hours. The programming process is the same for any timer.

When the desired timer is displayed, press  to access. SET symbol blinks to start the setting process:

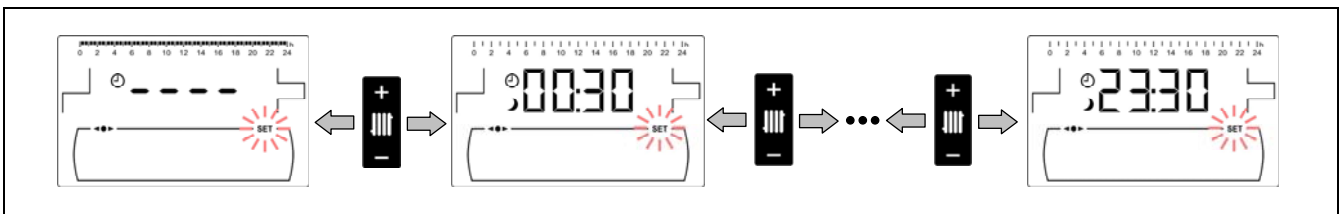

Select the time periods (30 minutes periods) by pressing "+" or "-" of heating (18).



When the period desired is selected, change it state by pressing "+" or "-" of DHW (19). The function will be switched off if symbol  is displayed and it will be switched on if symbol  is displayed.

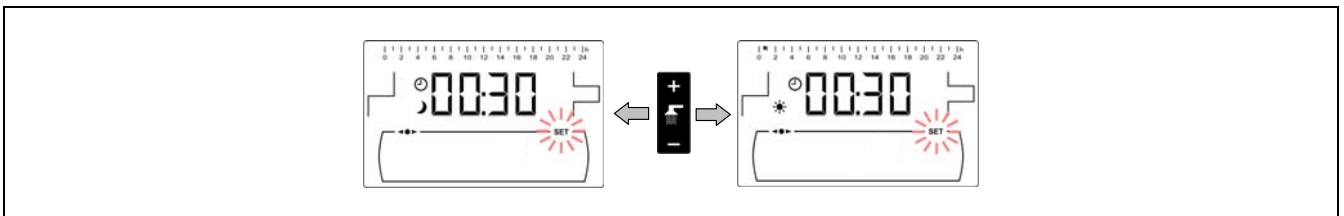

After setting all the periods desired, press  to save and return to "Setup menu" level.

12.2 Boiler timer programming

This timer is used to adjust the switching on and off periods of the boiler functioning. To disable the timer, select boiler timer programming () and set it to "- - -" by pressing "-" of the boiler temperature touch button (18). The boiler timer will be cancelled and it will be switched on permanently.

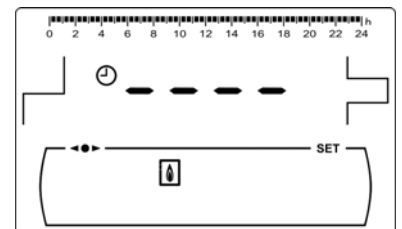

12.3 CVS Suction System timer programming (CVS Suction System option only)

This timer is only displayed when an **CVS Suction System** is connected to the boiler. It is used to adjust the switching on and off periods of the **CVS Suction System** functioning. To disable the timer, select the **CVS Suction System** timer programming () and set it to "- - -" by pressing "-" of the boiler temperature touch button (18). Kit timer will be cancelled and it will be switched on

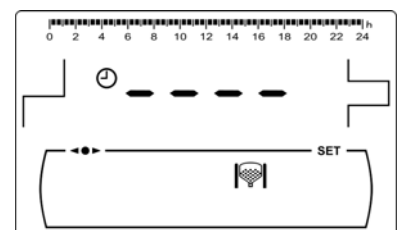

permanently.

12.4 DHW recirculation function timer programming (DHW tank option only)

This timer is only displayed when the DHW recirculation function is selected in the multifunction relay parameter (**P.20 = 2**) of the "Technical Menu". It is used to adjust the switching on and off periods of DHW recirculation pump. To disable the timer, select the DHW recirculation timer programming (🔧) and set it to "- - - -" by pressing "-" of the boiler temperature touch button (18). The timer will be cancelled and DHW recirculation pump will be switched on permanently.

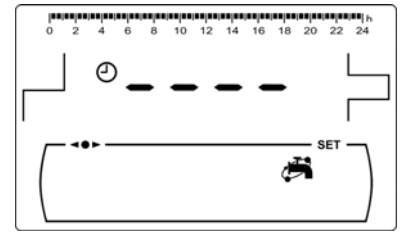

12.5 Time setting

When "Time setting" parameter of "Setup menu" is displayed, press 🔧 to access. The first two digits of numerical digits blinks (hours) and setting process begins:

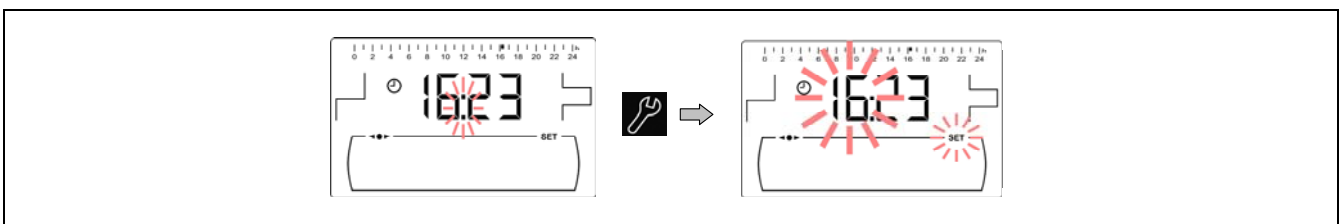

Set the hour value by pressing "+" or "-" of DHW (19). Pressing 🔧 the value is saved and the minutes digits blinks to set them.

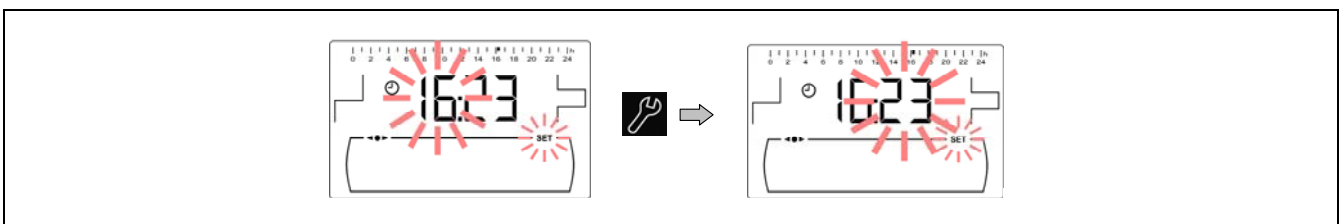

Set the minutes value by pressing "+" or "-" of DHW (19). Pressing 🔧 the value is saved and it returns to "Setup menu" level.

BioClass HM

12.6 Ashtray empty warning function

When this function is activated, the boiler's controller warns about the ashtray of the boiler is full and must be emptied, depending on boiler's fuel consumption (kg). The parameter "Ashtray status" of "User Menu" allows checking the actual fill level. When it is full, an "Empty the ashtray" warning is activated.

By default this function is supplied activated and set to a general default rough value, so it should be adjusted depending on the quality and type of fuel used. The following table shows the default value of this parameter in kilograms of fuel consumption (depending of boiler model):

Model	Fuel Kg
BioClass HM 10	650 kg
BioClass HM 16	750 kg
BioClass HM 25	1000 kg
BioClass HM 43	1350 kg

Select "Ashtray empty warning" (🔥) parameter of "Setup menu" and press 🔧 to access. The value is set by pressing "+" and "-" symbols of DHW (19). It is possible to deactivate this function by setting the value of this parameter to "OFF".



NOTE: Each time a new value is set for this parameter, the ashtray must be emptied.

12.7 Manual setting of feed auger calibration

When this parameter is displayed (📊) on "Setup menu", press 🔧 to access and set the value desired by pressing "+" or "-" of DHW (19). The range of values selectable is OFF, 0.500 - 5.000 kg.

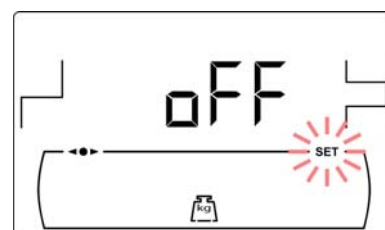



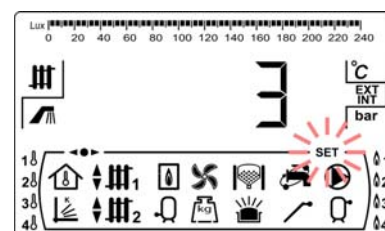

12.8 Screen contrast setting





When this parameter of the "Setup menu" is displayed, press 🔧 to access and set the value desired by pressing "+" or "-" of DHW (19). The range of values selectable is 1 - 5.



13 CALIBRATION MENU

"*Calibration Menu*" consists of a number of processes and parameters that allow the correct set up of the boiler.

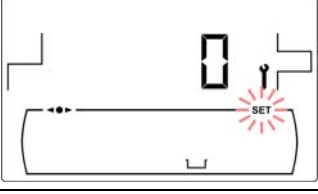
To access the "*Calibration Menu*", the boiler must be switched off by pressing  tactile button. After having switched off the boiler press  for 5 seconds to access to the menu. Browse through the menu by pressing the symbols "+" or "-" of heating (18). When the desired parameter is displayed, press  to access and set it. When the parameter or process has been set, press  again, the value will be saved and the display will return to "*Calibration menu*". Press RESET any time to go back without recording any value. In the following table are listed all the parameters and processes included in "*Calibration menu*".

Nº.	Parameter	Display
1	Feed auger filling	
2	Feed auger calibration	
3	Manual setting of feed auger calibration	
4	Manual ash cleaning activation	
5	Manual circulation pumps activation	

BioClass HM

13.1 Feed auger filling

During the commissioning of the boiler, before calibrating the feed auger or if the hopper runs out of fuel, **it is compulsory** to fill of fuel the feed auger. By means of this parameter the feed auger will be filled of fuel, process required for a correct boiler functioning.

When "Feed auger filling" parameter is displayed (🔧) on "Calibration Menu", press 🔧 to access. SET symbol blinks and pressing 🔧 again it will be activated filling procedure. The feed auger will be activated and a count up to 15 minutes (maximum) will be displayed. During the process by pressing 🔧 the feed auger could be stopped at any time and by pressing RESET the filling procedure could be finished and return to "Calibration Menu" at any time.

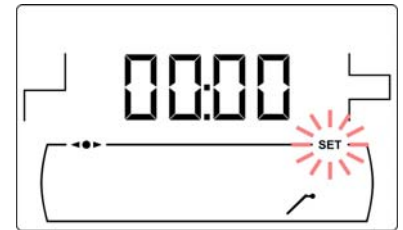

To ensure a complete filling of boiler feed auger it is recommended to make a complete 15 minute procedure of filling, at least once. Follow the steps shown in the following pictures for a correct filling of the feed auger:

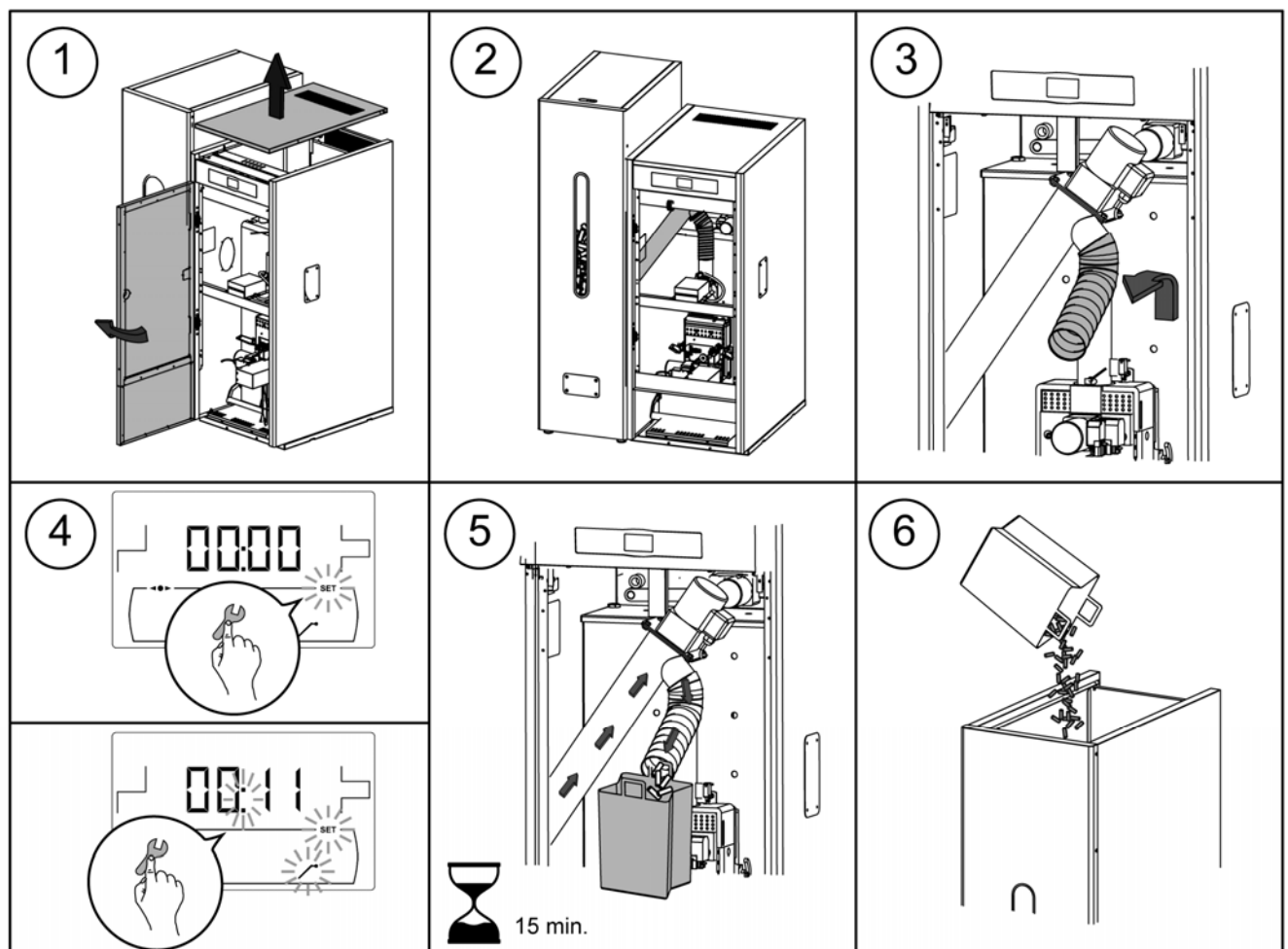

IMPORTANT: It is compulsory to fill the feed auger during the commissioning or when the hopper runs out of fuel.

13.2 Feed auger calibration

By means of calibrating the feed auger the electronic controller of the boiler adjusts the optimum amount of fuel required to supply the burner and to produce the correct heat output and combustion. By means of this parameter the feed auger calibration procedure will be made, process required for a correct boiler functioning. **In any case the hopper is empty or it runs out of fuel, it is compulsory to fill the feed auger before carrying out the calibration process. It is compulsory to calibrate the feed auger on commissioning and whenever the fuel supplier is changed** (not all suppliers provide fuel of the same quality and size).

When "Feed auger calibration" parameter is displayed (🔧) on "Calibration Menu", press 🔧 to access. SET symbol blinks and pressing 🔧 again it will be activated calibration procedure. The feed auger will be activated and a countdown from 200 doses will begin. When the countdown finishes current calibration value will be displayed, press 🔧 to adjust the new value obtained during the procedure by pressing "+" or "-" symbols of DHW (19). Finally pressing 🔧 the value will be saved and it will return to Calibration Menu level.

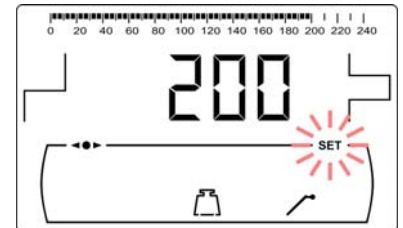

This process must be carried out at least twice to ensure the correct amount of fuel has been added. Follow the steps shown in the following pictures for a correct calibration of the feed auger:

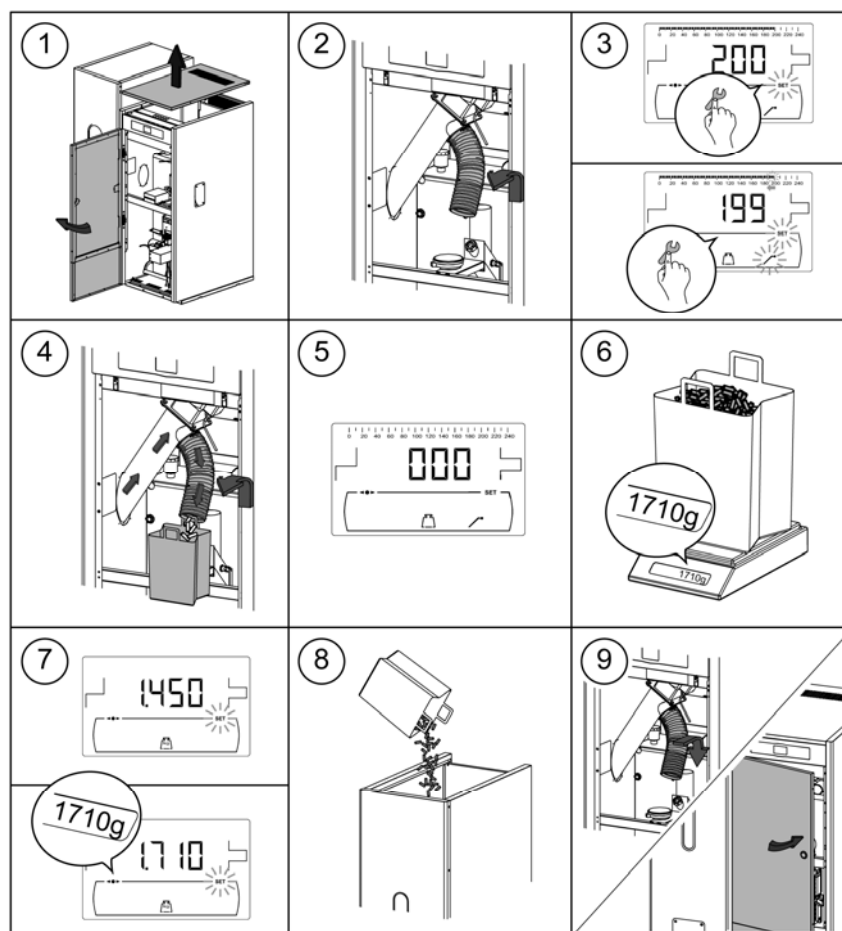

IMPORTANT: Calibrate the feed auger during commissioning of the boiler or whenever the fuel supplier has been changed.



BioClass HM

13.3 Manual setting of feed auger calibration

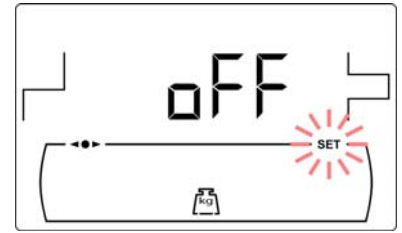
By means of this parameter the weight obtained in the feed auger calibration procedure can be set manually. When "Manual setting of feed auger calibration" parameter is displayed (kg) on "Calibration Menu", press  to access and set the value desired by pressing "+" or "-" of DHW (19). The range of values selectable is OFF, 0.500 - 5.000 g.



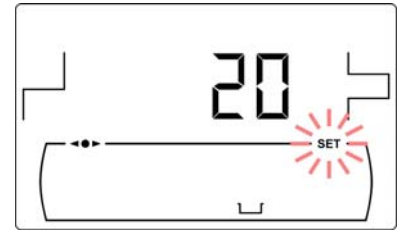

13.4 Manual ash cleaning activation

By means of this parameter the burner ash cleaning device can be switched on manually up to a maximum of 20 cleaning cycles. When "Manual ash cleaning activation" parameter is displayed (□) on "Calibration Menu", press  to access. SET symbol blinks and pressing  again it will be activated the cleaning system. A countdown of 20 cycles will be displayed. When the countdown is finished the cleaning device will stop. By pressing  the cleaning procedure can be stopped at any time and by pressing RESET it will return to "Calibration Menu" level.



13.5 Manual circulation pumps activation



By means of this parameter the circulation pumps can be switched on manually. When "Manual circulation pump activation" parameter is displayed (▶) on "Calibration Menu", press  to access. SET symbol blinks and pressing  again the circulation pumps will be activated for a period of not more than 20 minutes.









By pressing  the circulation pumps can be stopped at any time and by pressing RESET it will return to "Calibration Menu" level.

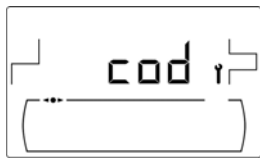
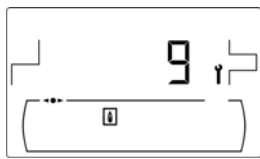

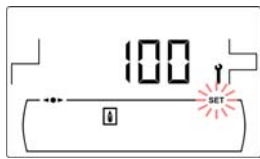
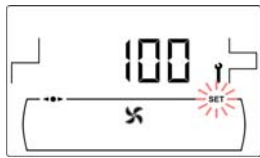

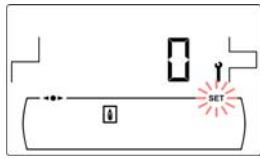
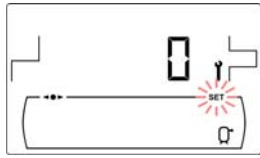
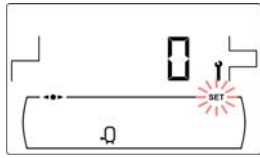



14 TECHNICAL MENU

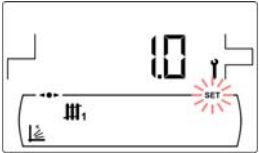

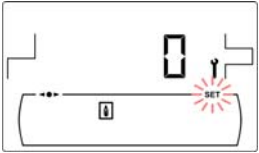
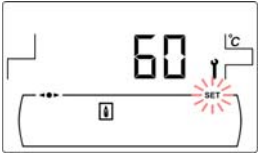

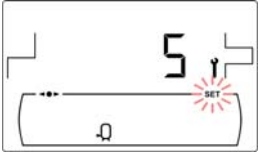
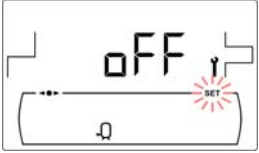
"Technical Menu" consists of a number of technical operating parameters that only have to be modified by a person with sufficient technical knowledge of the meaning of each parameter. Any inappropriate setting of a parameter of "Technical Menu" can cause a serious malfunctioning of the boiler and could cause damages to people, animals or things.

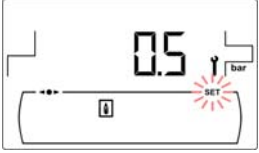
To access the "Technical Menu" press MENU and RESET tactile buttons together for 5 seconds. Access code ("cod") request will be displayed (see "Entry and set the access code"). After entering the correct code, the first parameter of "Technical menu" will be displayed. Browse through the menu (P.01, ..., P.25) by pressing the symbols "+" or "-" of heating (18). When the desired parameter is displayed, press  to access and set it by pressing the symbols "+" or "-" of DHW (19). When the parameter has been set, press  again, the value will be saved and the display will return to "Technical menu". Press RESET any time to go back without recording any value. The following table lists these parameters and they are described in detail in the following sections of the manual:

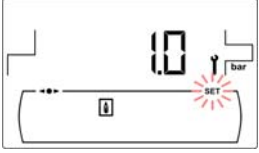
N°	Parameter	Display
Cod	Access code (by default 1234)	
P.01	Boiler model	
P.02	Minimum boiler heat output (%)	
P.03	Maximum boiler heat output (%)	
P.04	General fan speed factor (%)	
P.05	Fuel for ignition (g)	
P.06	Fuel consumption (kg/h)	
P.07	Fuel type	
P.08	Selecting the type of installation for the BT buffer tank <i>(Only with buffer tank installed)</i>	
P.09	DHW installation mode <i>(DHW tank option only)</i>	
P.10	OTC operating mode <i>(Bio Hydraulic kit option only)</i>	

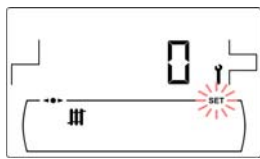
BioClass HM

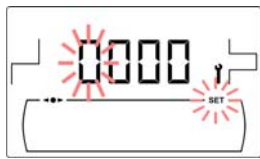
N°	Parameter	Display
P.11	Heating circuit n. 1 K-factor curve <i>(Bio Hydraulic kit option only)</i>	
P.12	Heating circuit n. 2 K-factor curve <i>(Bio Hydraulic kit option only)</i>	
P.13	Boiler minimum temperature mode	
P.14	Minimum boiler temperature (°C)	
P.15	Heating pump post-circulation time (min)	
P.16	DHW pump post-circulation time (min) <i>(DHW tank option only)</i>	
P.17	Legionella protection function <i>(DHW tank option only)</i>	
P.18	Boiler's pump operating mode (BC)	
P.19	Minimum boiler water pressure (bar)	
P.20	Multifunction relay	
P.21	Automatic water filling pressure(bar) <i>(P.20 = 3 option only)</i>	

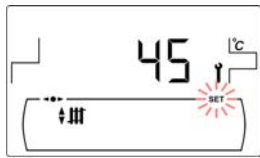
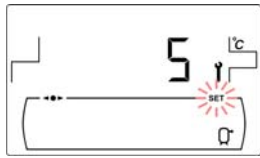
N°	Parameter	Display
P.22	CVS Suction System cycle time (s) <i>(CVS Suction System option only)</i>	
P.23	BIO Hydraulic Kit direct pump operating mode <i>(BIO Hydraulic Kit option only)</i>	
P.24	Reset default values	
P.25	Set access code	
P.26	Auxiliary parameter for fuel selection	
P.27	Maximum heating flow temperature of mixed circuits <i>(Only with the optional Hydraulic Kit Bio)</i>	
P.28	BT buffer tank temperature hysteresis <i>(Only with buffer tank installed)</i>	

14.1 Entry and set the access code ("cod", P.25)

When the access code request is displayed or to set a new one (P.25), press  to access. SET symbol blinks and it would be possible to enter the code or set it. Press the "+" o "-" for heating symbols (18) to browse trough the digits and press the "+" o "-" for DHW symbols (19) to set each digit. By default, the access code is "1234". The P.25 parameter allows to set a new access code.



15 BOILER'S SETUP PARAMETERS

The following parameters in the "*Technical Menu*" allow to adjust the boiler to each installation. They only may be modified by a person with sufficient technical knowledge of the meaning of each parameter. Any inappropriate setting of a parameter of "*Technical Menu*" can cause a serious malfunctioning of the boiler and could cause damages to people, animals or things.

15.1 Boiler Model (P.01)

Parameter **P.01** displays the model of the boiler set at DIP-switch on the electronic board.

P.01 = 10 => BioClass HM 10

P.01 = 16 => BioClass HM 16

P.01 = 25 => BioClass HM 25

P.01 = 43 => BioClass HM 43

15.2 Boiler heat output (P.02, P.03)

BioClass HM boiler is configured to modulate between a minimum and a maximum burner heat output. By means of parameters **P.02** and **P.03** the minimum and maximum heat output of the burner may be set at desired value. The range of modulation selectable depends on the model of boiler and the type of fuel set.

15.3 General fan speed factor (P.04)

By means of parameter **P.04** the fan speed percentage may be set, in order to increase or decrease the combustion air quantity and ensure a correct combustion. Changing its value affects the fan speed percentage for the entire modulation curve. If it is set below 100 % the air quantity will decrease and if it is set a higher value the air quantity will increase. The range of values selectable is 0 - 200 % (by default 100%).

15.4 Fuel for ignition (P.05)

By means of parameter **P.05** the amount of fuel for burner ignition procedure may be set at desired value. The default value depends on the model of boiler and the type of fuel set. The range of values selectable is 0 - 900 g.

15.5 Fuel consumption (P.06)

By means of parameter **P.06** the amount of fuel consumed by the boiler at 100% heat output may be set, in kilograms per hour. This parameter is related to the boiler model (heat output) and the type of fuel used, as well as its calorific value. The range of values selectable is 1.00 - 30.00 kg/h.

15.6 Fuel type (P.07)

By default **BioClass HM** boiler is configured to burn wood pellets. By means of parameter **P.07** another type of fuel may be selected:

P.07 = 0 => Wood pellet.

P.07 = 1 => Olive stone.

15.7 Managing BT and BT-DUO buffer tanks (P.08, P.28)

Parameter **P.08** is used to set the type of hydraulic installation that has been used for the **BT** or **BT-DUO** buffer tank. This parameter depends on the installation and must be set by the installer once the buffer tank has been assembled. The factory default value is 0, management function of BT buffer tanks disabled. The electronic control of the **BioClass HM** boiler is able to manage the operation of 4 different types of installation.

P.08 = 0 => Function disabled (default value).

P.08 = 1 => Installation with Sanit DHW tank after BT tank and control by temperature sensor.

P.08 = 2 => Installation with Sanit DHW tank before BT tank and control by temperature sensor.

P.08 = 3 => Installation with Sanit DHW tank after BT tank and control by thermostat.

P.08 = 4 => Installation with Sanit DHW tank before BT tank and control by thermostat.

When the installation type **1** or **2** is selected, by means of parameter **P.28**, it is possible to adjust the hysteresis of temperature for the sensor **Sbt**, in order to set the temperature to start up and stop the BT buffer tank heating operation. The parameter **P.28** can be adjusted between 5 and 40 °C and by default it is set to 5 °C.

15.8 Auxiliary parameter for fuel selection (P.26)

By means of parameter **P.26** the combustion may be set to the fuel characteristics. This parameter is related to the boiler model (heat output) and the type of fuel used. The range of values selectable is 0.000 - 99.99 kg/h and the default value depends on the model of boiler and the type of fuel set:

15.9 Boiler minimum temperature mode (P.13, P.14)

By means of parameters **P.13** and **P.14** a different mode of temperature managing may be set (by default **P.13 = 0**), if heating or/and DHW services are enabled. When parameter **P.13** is set to 0, by parameter **P.14** the minimum temperature can be selected as desired, between 30 and 60 °C. The following regulation modes of minimum temperature can be selected:

P.13 = 0 => Maintains the minimum temperature set at **P.14** parameter (by default).

P.13 = 1 => Maintains the boiler temperature set point.

P.13 = 2 => Does not maintain any boiler temperature.

16 HEATING CIRCUIT'S SETUP PARAMETERS

BioClass HM is equipped with an electronic controller to manage efficiently the automatic functioning of the boiler. It also has the following additional parameters to regulate the heating circuit connected. They only may be modified by a person with sufficient technical knowledge of the meaning of each parameter. Any inappropriate setting of a parameter of "*Technical Menu*" can cause a serious malfunctioning of the boiler and could cause damages to people, animals or things.

16.1 Heating pump post-circulation time (P.15)

This function keeps the heating pump (**BC**) running for a period of time after deactivating the heating service, to avoid the overheating due to the temperature inertias of the heating installation. By means of parameter **P.15** the period of time that the pump continues to operate may be set. The range of values selectable is 0 - 40 minutes (by default 3 minutes).

BioClass HM

16.2 Boiler's pump operating mode (P.18)

The electronic controller allows to select between two operating modes of boiler's circulating pump (**BC**) by means of **P.18** parameter of the *“Technical Menu”*. The following operating modes can be selected:

- P.18 = 0** => Standard mode: The circulation pump will be run depending if the heating demand is activated or not.
- P.18 = 1** => Continuous mode: The pump continues to run provided that the heating mode is enabled (boiler temperature set point different to OFF). If there is room thermostat or remote control connected to the boiler, the electronic controller will regulate the burner functioning according to the heating demand, keeping the pump running continuously.

16.3 Minimum boiler water pressure (P.19)

BioClass HM is equipped with a water pressure sensor that makes possible to know the pressure of the boiler. If the pressure descends below the value set at **P.19** parameter, the electronic controller locks out the functioning of the boiler and **E-19** alarm code is displayed (see *“Safety lock-outs”*). The range of values selectable is 0.1 - 0.5 bar (by default 0.5 bar).

16.4 Maximum heating flow temperature of mixed circuits (P.27)

The electronic controller allows to select the maximum heating flow temperature for mixed circuits installed in the boiler with an optional Bio Hydraulic Kit. By means of parameter **P.27** the maximum heating flow temperature may be set. The range of values selectable is 45 - 80 °C (by default 45 °C for mixed circuits)).

17 DHW CIRCUIT'S SETUP PARAMETERS

BioClass HM is equipped with an electronic controller to regulate a Domestic Hot Water production service, if a DHW tank is connected to the boiler. The following parameters are used to set the parameters related to DHW service. These parameters are only displayed if a DHW tank is connected. They only may be modified by a person with sufficient technical knowledge of the meaning of each parameter. Any inappropriate setting of a parameter of *“Technical Menu”* can cause a serious malfunctioning of the boiler and could cause damages to people, animals or things.

17.1 DHW installation mode (P.09)

BioClass HM could be set to be connected to a DHW production installation managed by a 3-way DHW diverter valve or by a hot water tank pump. These two operating modes can be selected by means of **P.09** parameter:

- P.09 = 0** => 3-way DHW diverter valve installation.
- P.09 = 1** => Hot water tank pump installation (by default).

17.2 DHW pump post-circulation time (P.16)

This function keeps the DHW valve or pump running for a period of time after deactivating de DHW service, to avoid the overheating of the boiler due to the temperature inertias of the DHW installation. By means of parameter **P.16** the period of time that the pump/valve continues to operate may be set. The range of values selectable is 0 - 20 minutes (by default 5 minutes).

17.3 Legionella protection function (P.17)

This option prevents the proliferation of legionella bacteria in the DHW tank. Every 7 days the temperature of tank hot water is increased to 70 °C to kill the bacteria. This function is only active if the boiler is turned on and a DHW tank is connected. By means of parameter **P.17** the protection against Legionella bacteria function may be activate or deactivate. By default this function is set deactivated.

17.4 DHW re-circulation function (P.20 = 2)

The multifunction of the auxiliary relay output allows to install a DHW re-circulating pump in DHW hydraulic circuit, in order to increase the comfort of DHW service. To activate this function read "*Multifunction-Relay functions*" section.

18 ADDITIONAL FUNCTIONS

BioClass HM boiler includes the following additional control functions. They only may be modified by a person with sufficient technical knowledge of the meaning of each parameter. Any inappropriate setting of a parameter of "*Technical Menu*" can cause a serious malfunctioning of the boiler and could cause damages to people, animals or things.

18.1 CVS Suction System cycle time (P.22)

BioClass HM boiler allows the installation of an optional automatic fuel loading system **named CVS Suction System**. By means of parameter **P.22** the activation cycle time of the loading system may be set. This parameter will be available only if an **CVS Suction System** is connected to the boiler. The range of values selectable is 35 - 195 seconds (by default 195 s). For a detailed information follow the instructions included within the **CVS Suction System**.

18.2 Reset default values (P.24)

In case any parameter is wrongly set or if the boiler works incorrectly, all the original values of the parameters can be reset automatically by selecting "Yes" in **P.24** parameter.

18.3 Pumps anti-lock function

This function prevents the boiler circulating pumps from locking if they have been out of use for a long period of time. This system remains enabled while the boiler is plugged into the mains.

18.4 Anti-frost function

This function protects the boiler from freezing during cold weather periods. If the boiler temperature drops below 6 °C, the heating pump will start running until the boiler temperature reaches 8 °C. If the boiler temperature continues to drop below 4 °C, the burner will start running, in order to heat the installation. It will continue working until the boiler reaches 15 °C. This system remains on standby while the boiler is plugged into the mains.

18.5 Boiler pressure sensor function

This function prevents boiler failure caused by a low or high water pressure level in the boiler. The pressure is detected by a pressure sensor and its value appears on the control panel display (in the "*User Menu*"). When the pressure drops below the pressure set at **P.19** parameter (by default 0.5 bar), the electronic controller locks out the boiler functioning and displays **E-19** alarm code on the screen. When the boiler pressure exceeds 2.5 bar, **H1** alarm code is displayed on the screen, warning about the excess of pressure. When it occurs repeatedly it is recommended calling the nearest

BioClass HM

Technical Assistance Service and draining the boiler water until the pressure is between 1 and 1.5 bar.

18.6 Connecting the LAGO FB OT+ remote control

The boiler has the terminal strip **J5** for connecting the **LAGO FB OT+** remote control (see "*Connection Diagram*") that allows to regulate boiler's heating circuit according to the room temperature, besides adjusting the DHW temperature (as long as the DHW temperature sensor is connected in the boiler).

Installing a **LAGO FB OT+** remote control enables the heating and DHW services to adapt to the scheduled times of use of the installation. It also optimises the installation's functioning, adapting the heating temperature set point to the room temperature, improving the comfort.

18.7 Room thermostat connection

The boiler has a terminal strip **J6** for connecting a room thermostat or a room chrono-thermostat (TA₁, see "*Connection Diagram*") that allows to switch on and off the heating circuit demand according to the actual room temperature. The terminal strip **J6** is supplied with a electrical bridge connecting its terminals, so it will be necessary to remove it before connecting the room thermostat.

Installing a room thermostat will optimise the installation's performance, adapting the heating to building requirements and obtaining enhanced comfort. Also, if the thermostat allows the hours of functioning to be programmed (chronothermostat), it can adapt the heating system to the hours of use of the installation.

19 MULTI-FUNCTIONAL RELAY (P.20)

BioClass HM is equipped with an auxiliary relay output that may be used to select a series of additional functions that increase the boiler performance, features and comfort of the installation.

Several operating modes may be set at **P.20** parameter of the "*Technical Menu*" to define the "*multi-functional relay*" function. The default value of this parameter is 0 (disabled). The following sections describe the functions that could be set.

19.1 Boiler alarms external signal (P.20 = 1)

When this function is selected (**P.20 = 1**) if the boiler shows an error or an operating alarm code the multi-functional relay output will be activated, supplying voltage (230 V~) between terminals no. **4**: "**NO**" and **N** of the terminal strip **J3**, where any external alarm signalling device may be connected to warn of boiler malfunctioning.

When the boiler lockage is reset, the multi-functional relay output will supply voltage again (230 V~) between terminals no. **3**: "**NC**" and **N** of the terminal strip **J3**.

19.2 DHW re-circulation function (P.20 = 2)

This function is available only if a DHW tank is connected on the boiler. The DHW recirculation function (**P.20 = 2**) will keep the whole DHW installation hot during the operating periods programmed in the boiler, so when any hot water tap is turned on the hot water will be supplied instantly, increasing the comfort of the DHW installation.

A DHW re-circulation pump will be required to install in the installation. This pump has to be connected in the multi-functional relay output, between the terminals No **4 (NO)** and **N** of the

terminal strip **J3** (see "*Connections diagram*"). The hydraulic installation and electrical connection of re-circulation system must be made by qualified personnel.

During the operating periods programmed in the boiler, the multi-functional relay output will be activated, supplying voltage (230 V~) between terminals No **4** ("**NO**") and **N** of the terminal strip **J3**, where the recirculation pump must be connected. During the switched off periods programmed the multi-functional relay output will be deactivated, supplying voltage (230 V~) between terminals No **3** ("**NC**") and **N** of the terminal strip **J3** and the re-circulation pump will be stop.

19.3 Automatic water filling function (P.20 = 3)

BioClass HM boiler may be connected to an automatic water filling system which can be activated or deactivated by **P.20** parameter.

It will be required to install a motorised valve to filling the water between the distribution water and the primary circuit of the boiler. This valve has to be connected in the multi-functional relay output between the terminals No **4** (**NO**) and **N** of the terminal strip **J3** (see "*Connections diagram*"). The hydraulic installation and electrical connection of the automatic water filling system must be made by qualified personnel.

If the function is enabled (**P.20 = 3**) the electronic controller of the boiler will active the multi-functional relay output supplying voltage (230 V~) between the terminals No **4** (**NO**) and **N** of the terminal strip **J3** (see "*Connections diagram*") that activates the connected filling valve to refill the primary circuit up to the pressure set at **P.21** parameter. If the boiler pressure drops below the minimum pressure set at **P.19** parameter the boiler will automatically fill up again until the filling pressure value is reached.

BioClass HM

20 CLEANING THE ASH DRAWER

BioClass HM boiler is equipped with an ash drawer, where the solid residues from the burnt fuel are collected on cleaning procedures of the burner and heat exchanger. This drawer must be regularly cleaned to prevent ash from accumulating and obstructing heat exchanger, what would cause the boiler to block out. It is recommended to check regularly the drawer and remove the ash that is accumulated (see "*Ashtray empty warning function*").

DOMUSA TEKNIK supplies an optional ash compacting device for to be installed within the boiler, so that the ash does not need to be removed so frequently.

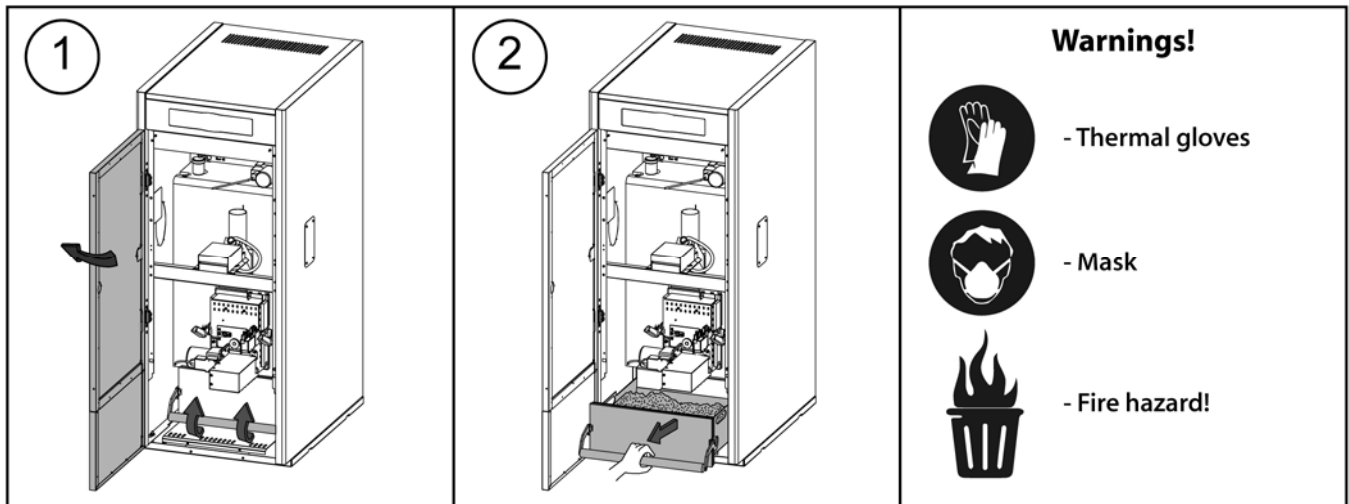

20.1 Safety warnings:

For **safe handling** of the ash drawer, you should take the necessary safety precautions and wear suitable clothing to protect against possible injury. The following advice should be particularly taken into account:

- **Switch off the boiler** before taking out the ash drawer. It is recommended to take out the ash drawer when no flame is detected in the burner.
- It is recommended to wear insulating **thermal gloves** to protect your hands from any burns from hot parts of the drawer.
- It is recommended you wear a protective **mask** to avoid breathing in any ash particles, particularly in the case of people with allergies or any type of respiratory problems, who should always wear a mask when carrying out ash removal.
- As the ash to be removed from the drawer may be burning or glowing, special precautions should be taken regarding to the type of container it is emptied into. A **metal** container is recommended, if not **the ash should be totally put out** using water or another extinguishing agent.

DOMUSA TEKNIK shall not be liable for any damage caused to people, animals or property as a result of incorrect handling of the ash drawer or the ash itself.

IMPORTANT: The ash drawer must only be cleaned when the boiler is switched off or on pause.

21 SAFETY LOCK-OUTS

The boiler's electronic controller may activate the following safety lock-outs to stop the boiler functioning in order to prevent serious damages. When any of these lock-outs occur, the boiler will switch off and an alarm code will be displayed on boiler's screen.

IMPORTANT: If any of the safety lock-outs described below should occur repeatedly, switch off the boiler and put in contact with the nearest official Technical Assistance Service.

21.1 Water overheat safety lock-out (E-11)

When this lock-out occurs "**E-11**" alarm code (temperature alarm) will appear on the screen. The burner will switch off and stop heating the installation.

This lock-out occurs when the temperature of boiler's water exceeds 110 °C. To unlock it, wait until the temperature drops below 100 °C and press the button of the safety thermostat, located underside of the electrical case of the boiler, after having removed the button cover:

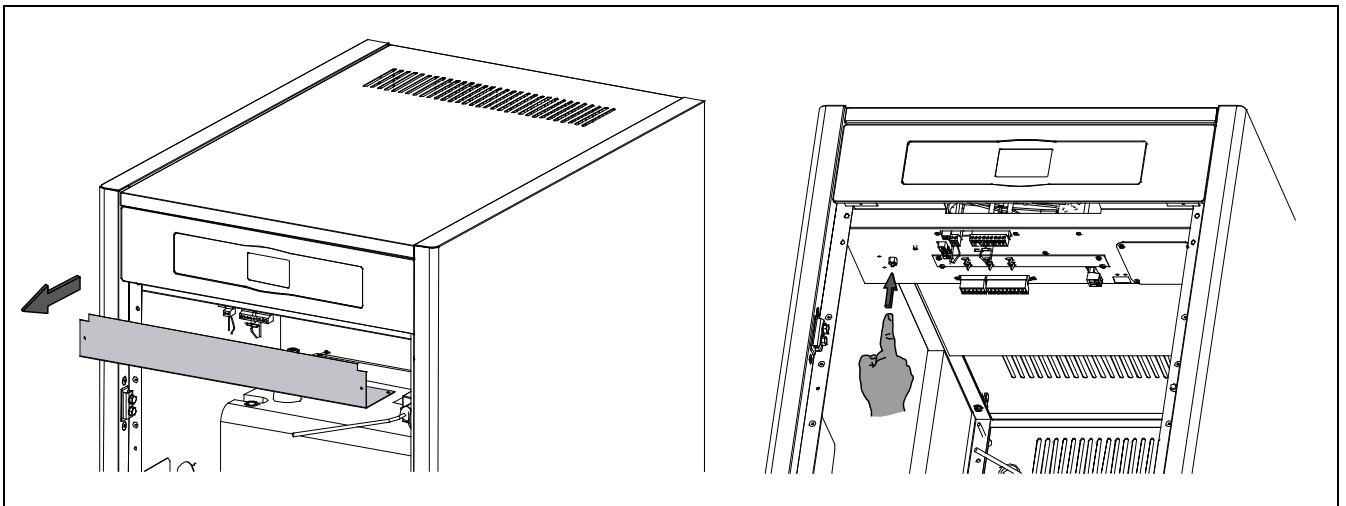

21.2 Fuel entrance tube overheat safety cut-out (E-05)

When this lock-out occurs "**E-05**" alarm code will appear on the screen. The burner will switch off and stop heating the installation.

This lock-out occurs when the temperature of the fuel entrance tube exceeds 80 °C. To unlock it, wait until the temperature drops and press the button on the safety thermostat using a screwdriver or a pen as is shown in the picture below:

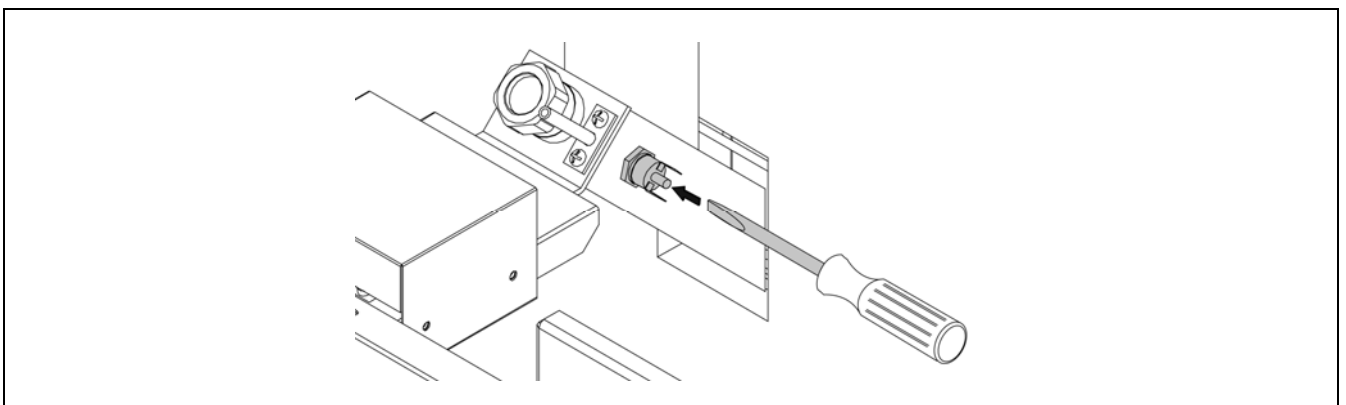

BioClass HM

21.3 Low pressure lock-out

When this lock-out occurs, **"E19"** alarm code will appear on the digital display. The burner and the boiler's circulation pumps will switch off, cutting off the heating and water flow to the installation.

This lock-out occurs when the pressure of boiler's water drops below the value set at **P.19** parameter of *"Technical menu"* (by default 0.5 bar), preventing the boiler from functioning when the water is drained from the installation, due to either leakage or maintenance operations. To unlock this alarm, fill the installation again (see *"Filling the installation"*) up to 1 or 1.5 bar, displayed on *"Water pressure"* parameter of *"User menu"*.

22 SHUTTING DOWN THE BOILER

Press  during 1 second to shut down the boiler. When the boiler is shut down the heating and DHW services are switched off but anti-frost and pumps anti-lock functions continue activated whereas the boiler is kept connected to the power supply and fuel installation.

Unplug the boiler from the power supply and cut out the fuel supply to shut down the boiler completely.

23 EMPTYING THE BOILER

Use the drain cock located on the bottom of the backside of the boiler to empty it of water. Before opening it, connect a flexible pipe leaded to a sewer. After finishing the procedure, close the cock and remove de flexible pipe.

24 BOILER MAINTENANCE

Various maintenance operations should be carried out at different intervals of time to keep the boiler in perfect working order. The yearly maintenance operations should be carried out by personnel authorised by **DOMUSA TEKNIK**.

24.1 Frequency of maintenance of the boiler and chimney

The most important aspects to be checked are as follows:

N°	Operation	Frequency
1.	Check the fuel storage.	weekly
2.	Clean the ash in the ash drawer.	as required
3.	Check the boiler visually.	weekly
4.	Check if the feed auger is correctly calibrated.	as required
5.	Check and clean the boiler fume circuit.	yearly
6.	Check and clean the chimney. The chimney must be free of any obstacles and have no leaks.	yearly
7.	Clean the burner.	yearly

8.	Check the expansion vessel. It must be full, according to its data plate.	yearly
9.	Check the seal between the burner and the boiler.	yearly
10.	Check if the hydraulic circuits are correctly sealed.	yearly
11.	Check the water pressure of the boiler. When the installation is cold , it should be between 1 and 1.5 bar.	yearly

NOTE: Depending on the fuel type and weather conditions, it may be necessary to clean the combustion chamber of the burner at a bigger frequency.

24.2 Burner cleaning procedure

The following procedure is recommended for a correct cleaning of the burner:

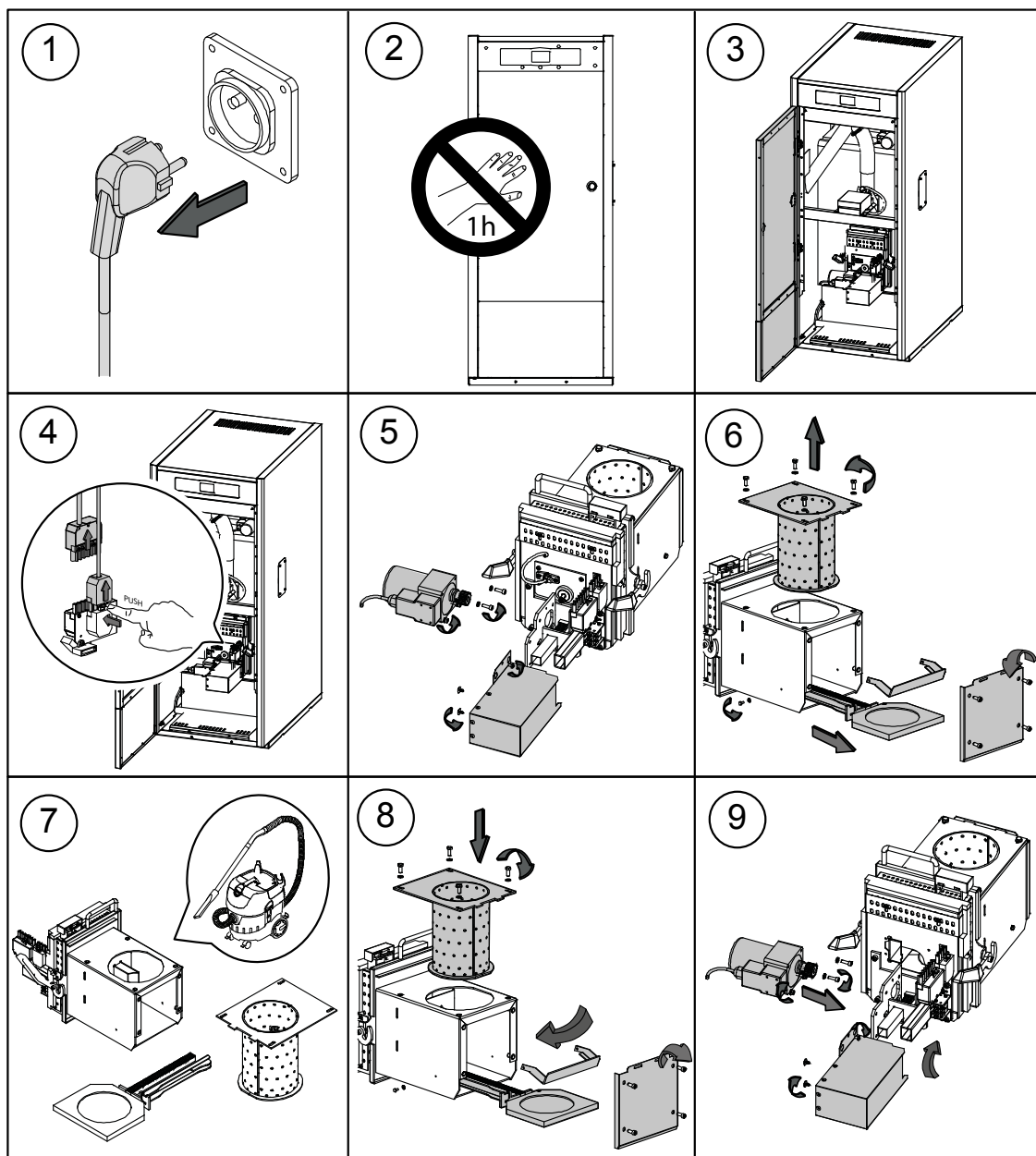

BioClass HM

24.3 Heat exchanger cleaning procedure

The following procedure is recommended for correctly cleaning the heat exchanger:

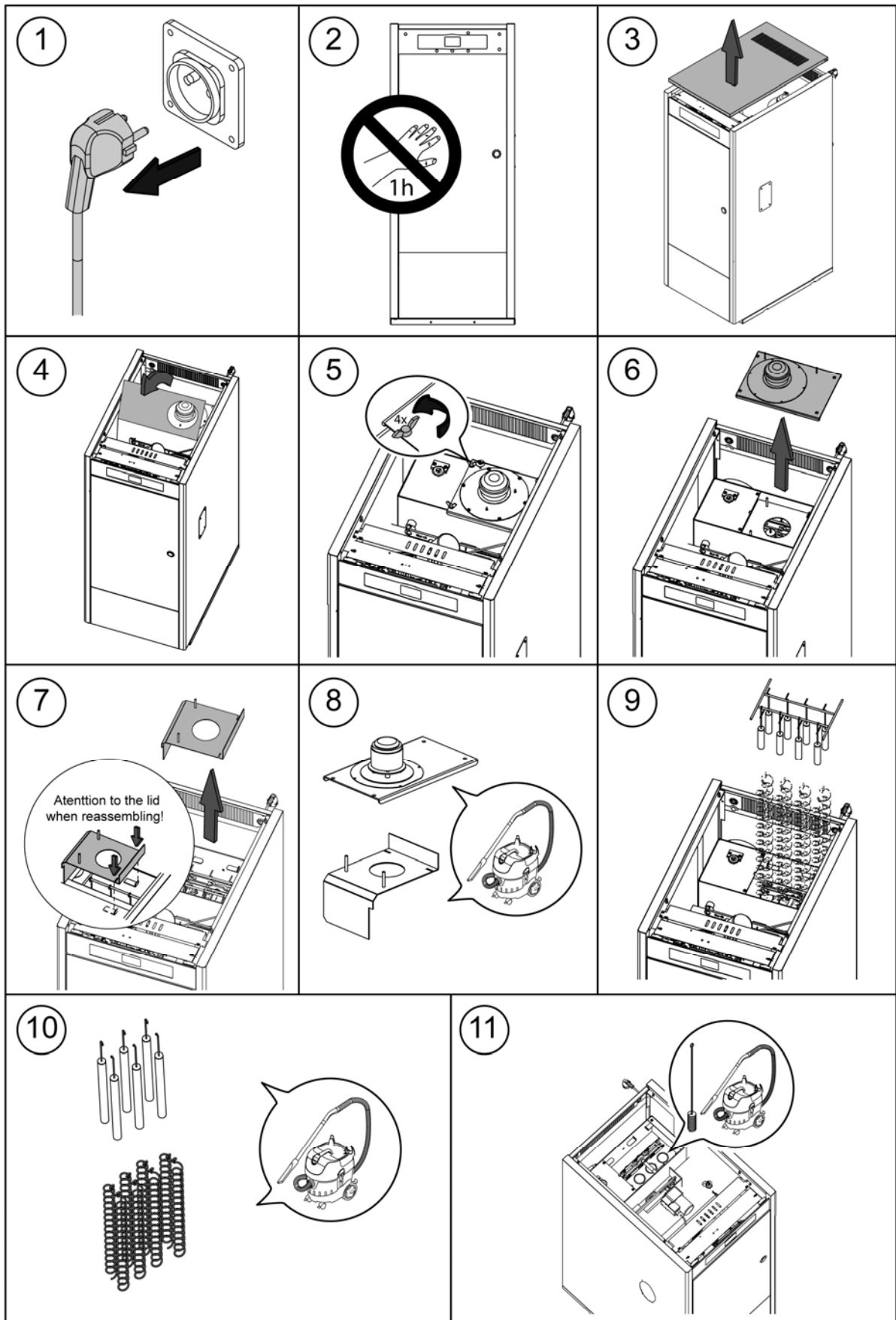

24.4 Draining the condensate water

The draining device to take out the condensate water from the chimney should not be altered in any way and it must be kept free of obstructions.

24.5 Boiler water characteristics

In areas with water hardness of over 25-30 °fH, treated water must be used in the heating installation to avoid any scale deposits on the boiler. It should be noted that even a few millimetres of scale will greatly reduce the boiler's heat conductivity, causing a major drop in performance.

Treated water must be used in the heating circuit in the following cases:

- Very large circuits (containing a large amount of water).
- Frequent filling of the installation.

If it is necessary to drain partially or totally the water of the installation very often, we recommend filling it with treated water.

25 DIAGRAMS AND MEASUREMENTS

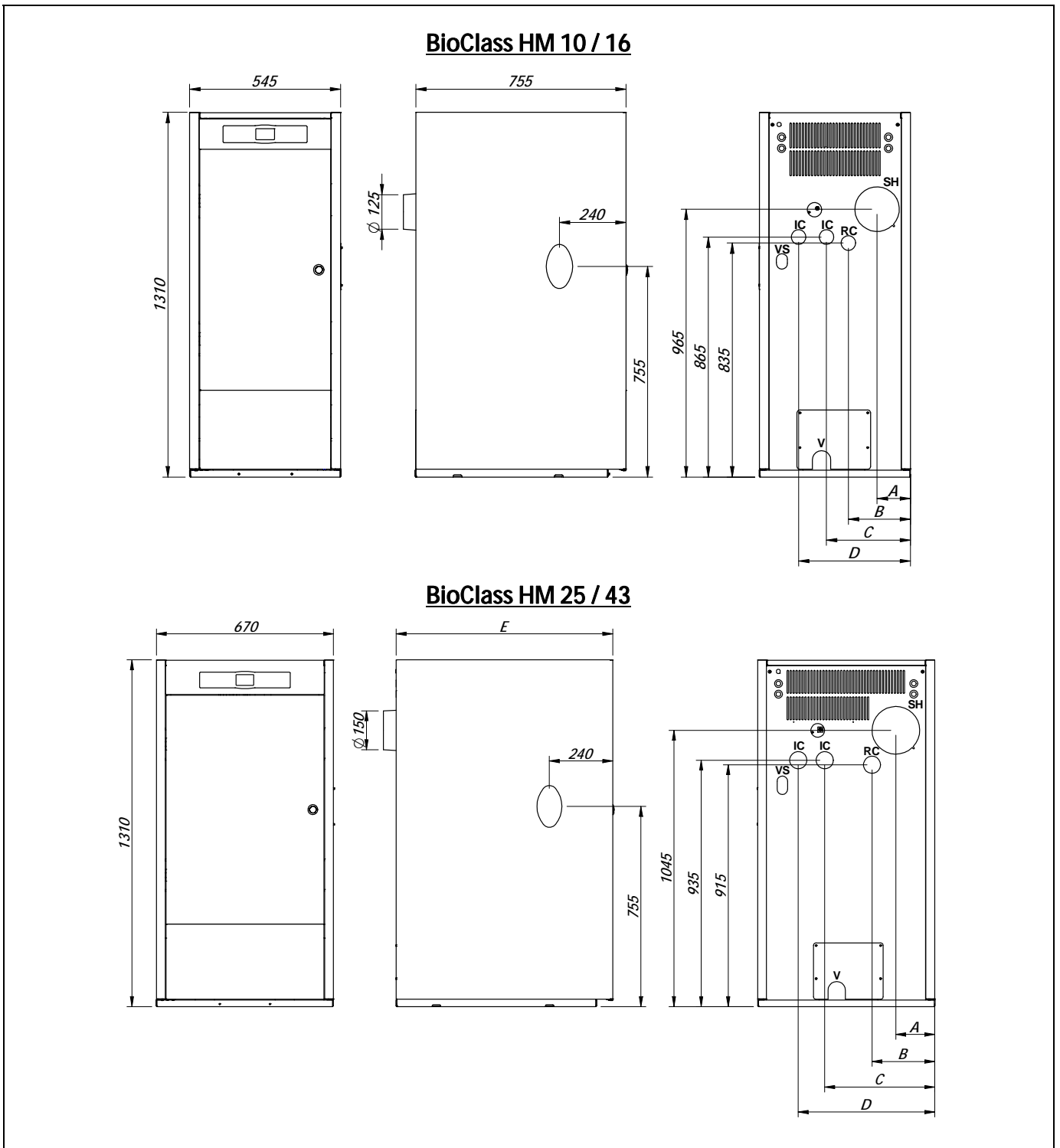

IC: Heating flow.
RC: Heating return.
SH: Fume outlet.
V: Drainage cock.
VS: Pressure relief valve, 1/2" F.

		Dimensions (mm)				
	IC/RC	A	B	C	D	E
BioClass HM 10	1" F	150	260	340	440	-
BioClass HM 16		120	225	300	400	-
BioClass HM 25	1 1/4" F	145	235	415	515	820
BioClass HM 43		150	240	420	520	1045

S Hopper

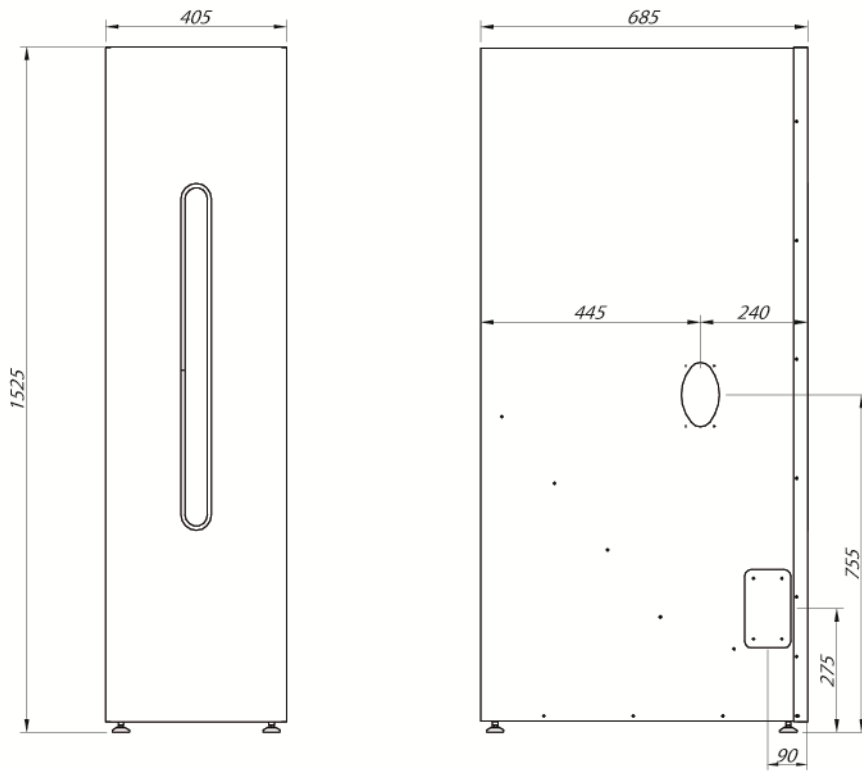

L Hopper

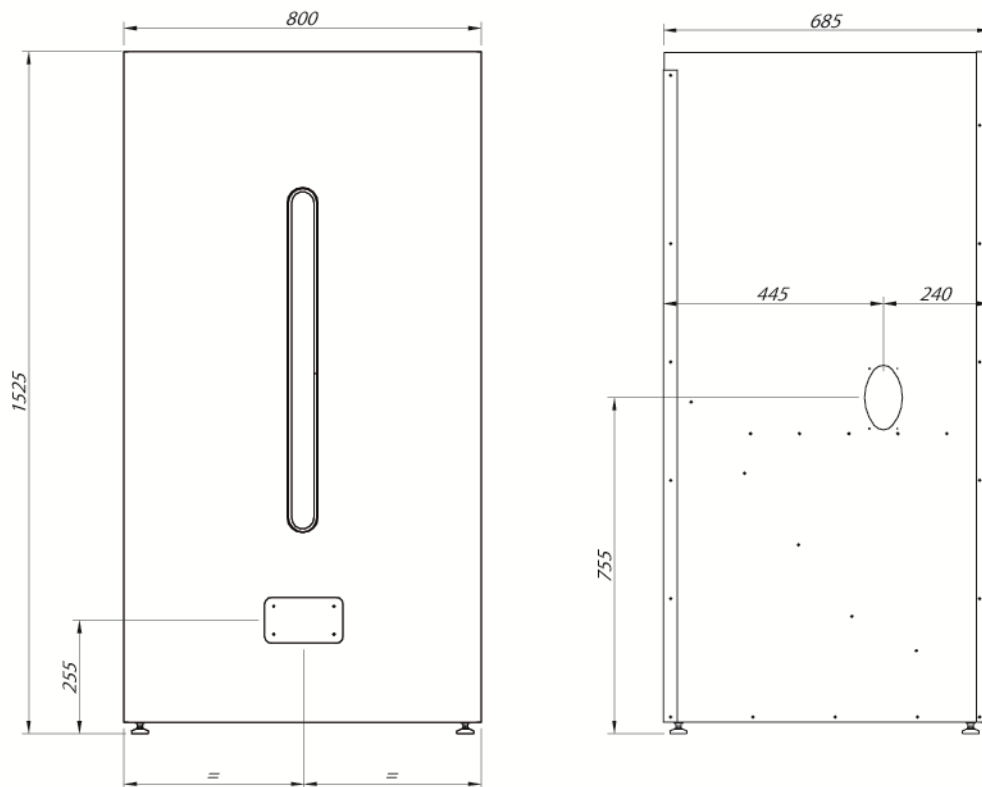

BioClass HM

Removable Hopper

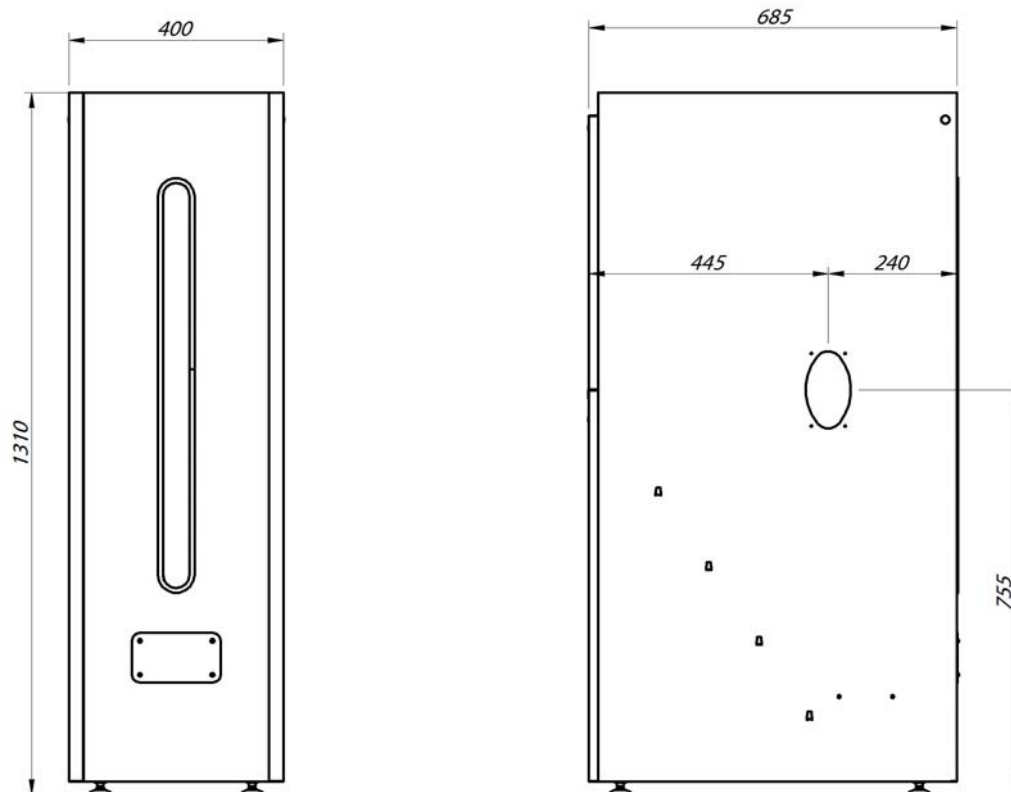

	S Hopper		L Hopper		Removable Hopper	
	P _c	Size	P _c	Size	P _c	Size
BioClass HM 10	93	300 litres	162	520 litres	66	215 litres
BioClass HM 16	58		101		42	
BioClass HM 25	37		65		27	
BioClass HM 43	21		38		16	

P_c: Combustion period in hours at Q_N.

26 CONNECTIONS DIAGRAM

26.1 Boiler

BioClass HM

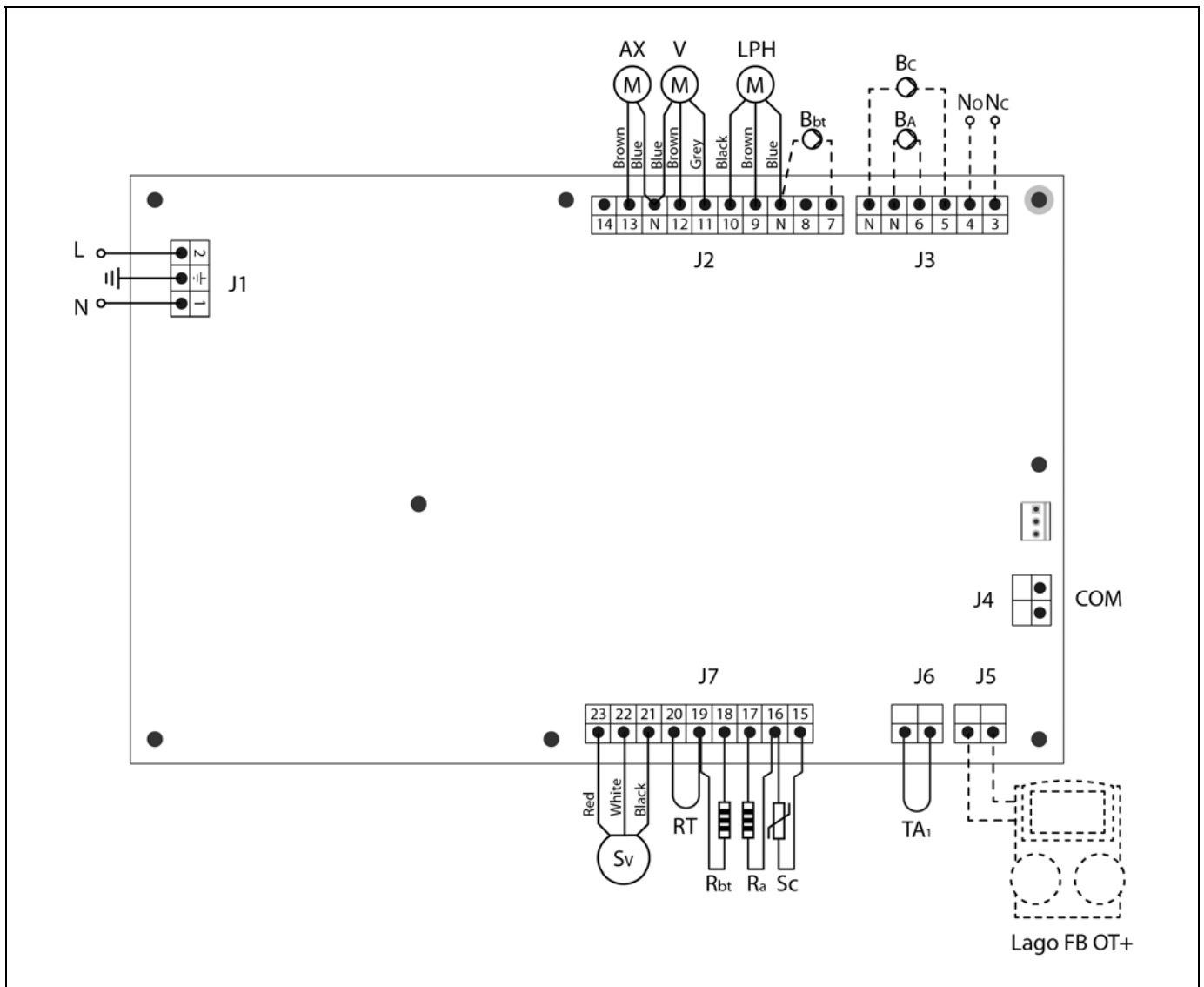

- L:** Phase.
- N:** Neutral.
- AX:** Feed auger.
- V:** Fan.
- LPH:** Heat exchanger cleaning device.
- Bbt:** BT buffer tank charging pump.
- BC:** Boiler pump.
- BA:** DHW tank pump or DHW valve.
- NO:** Multi-functional relay.
- NC:** Multi function relay.
- TA₁:** Room thermostat.
- Sc:** Boiler temperature sensor.
- Ra/Sa:** DHW tank option resistance.
- Rbt/Sbt:** Resistance for BT tank Option.
- RT:** Remote relay.
- Sv:** Fan speed sensor.
- J1:** Power supply connector.
- J2:** Component connector.
- J3:** Component connector.
- J4:** Communication connector.
- J5:** **LAGO FB OT+** remote control connector.
- J6:** Room thermostat connector.
- J7:** Sensors connector.

26.2 Burner

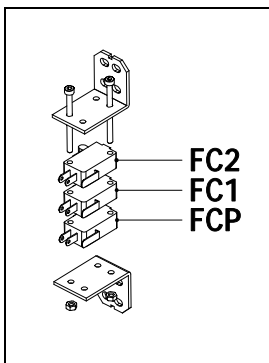
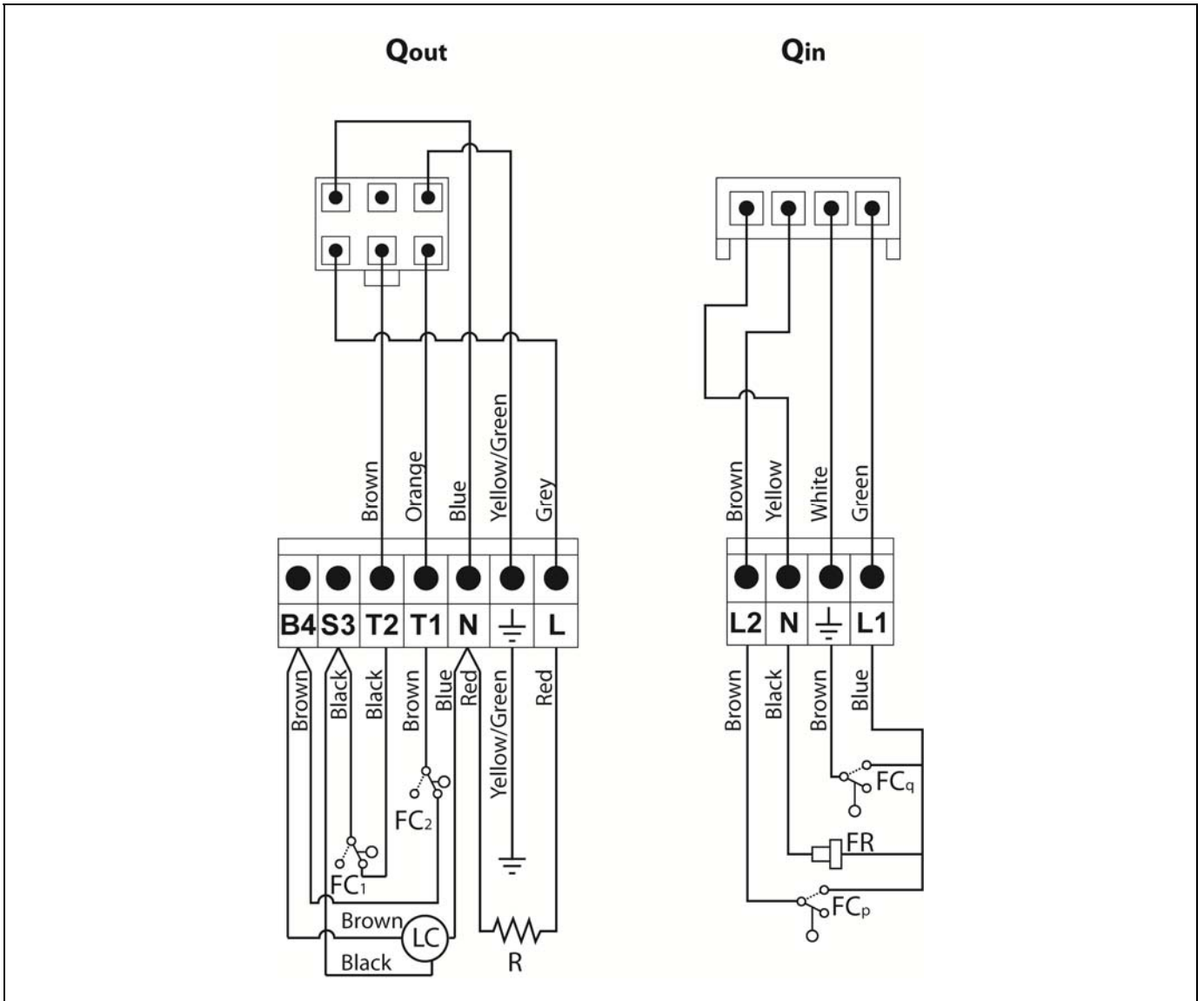

Qout: Burner outputs connector.

R: Ignition heater.

LC: Burner ash cleaning device.

FC₁: Closed switch.

FC₂: Open switch.

Qin: Burner inputs connector.

FC_q: Burner switch.

FR: Photocell.

FC_p: Ash cleaning device switch.

27 ELECTRICAL DIAGRAM

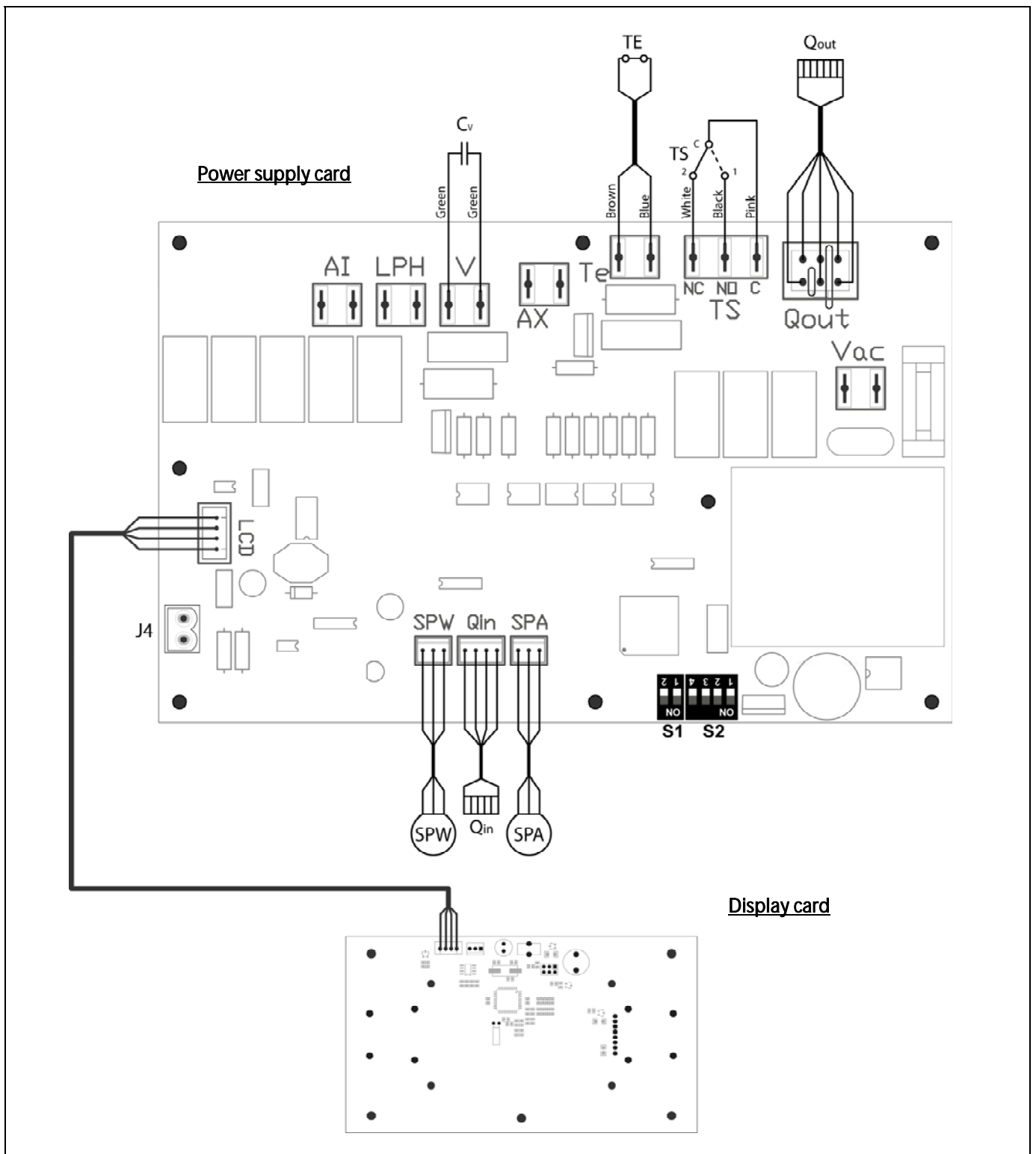

- TS:** Safety thermostat.
- TE:** Fuel entrance safety thermostat.
- Cv:** Fan capacitor.
- SPW:** Water pressure sensor.
- SPA:** Air pressure sensor.

- Qout:** Burner outputs connector.
- Qin:** Burner inputs connector.
- LCD:** Display communication connector.
- J4:** Communication connector.
- S1, S2:** Boiler model DIP-switch.

28 CHARACTERISTICS OF THE CIRCULATION PUMP

The characteristics and functionalities of the circulation pump are described below.

28.1 Characteristics of the SC pump

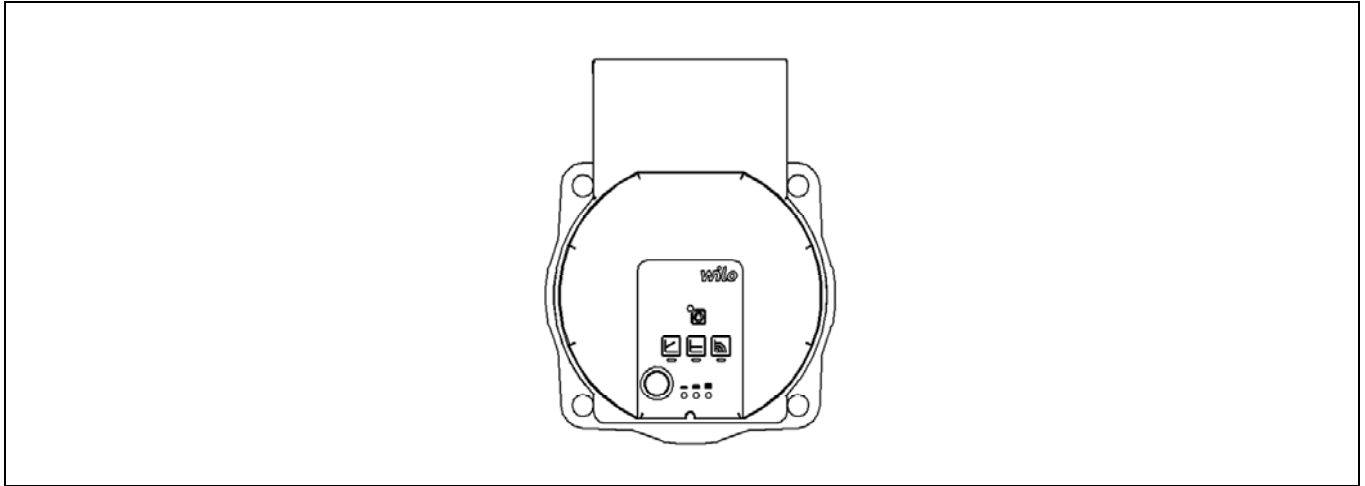

28.1.1 Symbology

Indicator lights (LEDs)



- Signal display:
 - LED is lit up in green in normal operation.
 - LED lights up/flashes in case of a fault.



- Display of selected control mode $\Delta p-v$, $\Delta p-c$ and constant speed.



- Display of selected pump curve (I, II, III) within the control mode.



- LED indicator combinations during the pump venting function, manual restart and key lock.



Operating button



Press:

- Select control mode.
- Select pump curve (I, II, III) within the control mode.



Press and hold

- Activate the pump venting function (press for 3 seconds).
- Activate manual restart (press for 5 seconds).
- Lock/unlock button (press for 8 seconds).

28.1.2 Control modes

1-Constant speed I, II, III (traditional mode):

The pump operates at a constant, pre-set speed.









2-Variable differential pressure ($\Delta p-v$):

The setpoint value of the differential pressure H increases in a straight line between $\frac{1}{2}H$ and H within the permitted flow margin. The differential pressure generated by the pump is adjusted to the appropriate setpoint value of differential pressure.

3-Constant differential pressure ($\Delta p-c$):

The control keeps the set delivery head constant irrespective of the pumped volume flow.

4-Setting the control mode

	LED display	Control mode	Pump curve
1		Constant speed	II
2		Constant speed	I
3		Variable differential pressure $\Delta p-v$	III
4		Variable differential pressure $\Delta p-v$	II
5		Variable differential pressure $\Delta p-v$	I
6		Constant differential pressure $\Delta p-c$	III
7		Constant differential pressure $\Delta p-c$	II
8		Constant differential pressure $\Delta p-c$	I
9		Constant speed	III

Pressing the button for the 9th time returns to the basic setting (constant speed / characteristic curve III).

BioClass HM

28.1.3 Functions

Venting

- Fill and vent the system correctly.

If the pump does not vent automatically:

- Activate the pump venting function via the operating button: press and hold for 3 seconds, then release.
- The pump venting function is initiated and lasts 10 minutes.
- The top and bottom LED rows flash in turn at 1 second intervals.
- To cancel, press and hold the operating button for 3 seconds.

However, this function does not vent the heating system.

Lock

- To activate the key lock, press and hold the operating button for 8 seconds until the LEDs for the selected setting briefly flash, then release.
- LEDs flash constantly at 1-second intervals.
- The key lock is activated: pump settings can no longer be changed.
- The key lock is deactivated in the same manner as it is activated.

It protects against undesired or unauthorized adjustment of the pump.

Activating factory setting

The factory setting is activated by pressing and holding the operating button whilst switching off the pump.

- Press and hold the operating button for at least 4 seconds.
- All LEDs flash for 1 second.
- The LEDs for the last setting flash for 1 second.

When the pump is switched on again, the pump runs using the factory settings (delivery condition).

Manual restart

- The pump attempts an automatic restart upon detecting a blockage.

If the pump does not restart automatically:

- Activate manual restart via the operating button: press and hold for 5 seconds, then release.
- The restart function is initiated, and lasts max. 10 minutes.
- The LEDs flash in succession clockwise.
- To cancel, press and hold the operating button for 5 seconds.

Characteristic curve of the circulation pump for constant speed mode I, II, III:

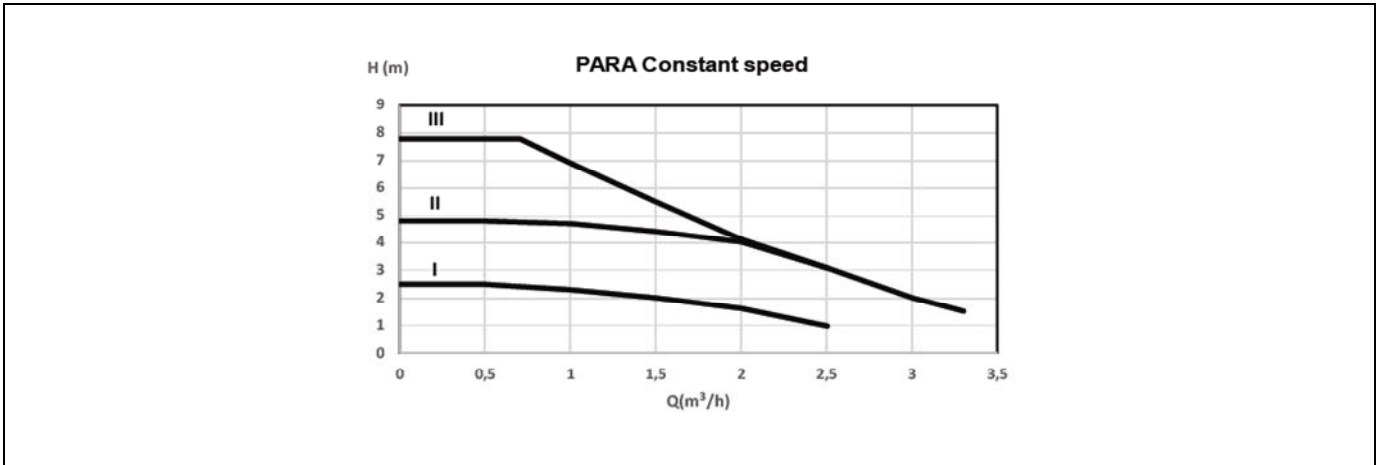

Characteristic curve of the circulation pump for the variable differential pressure mode:

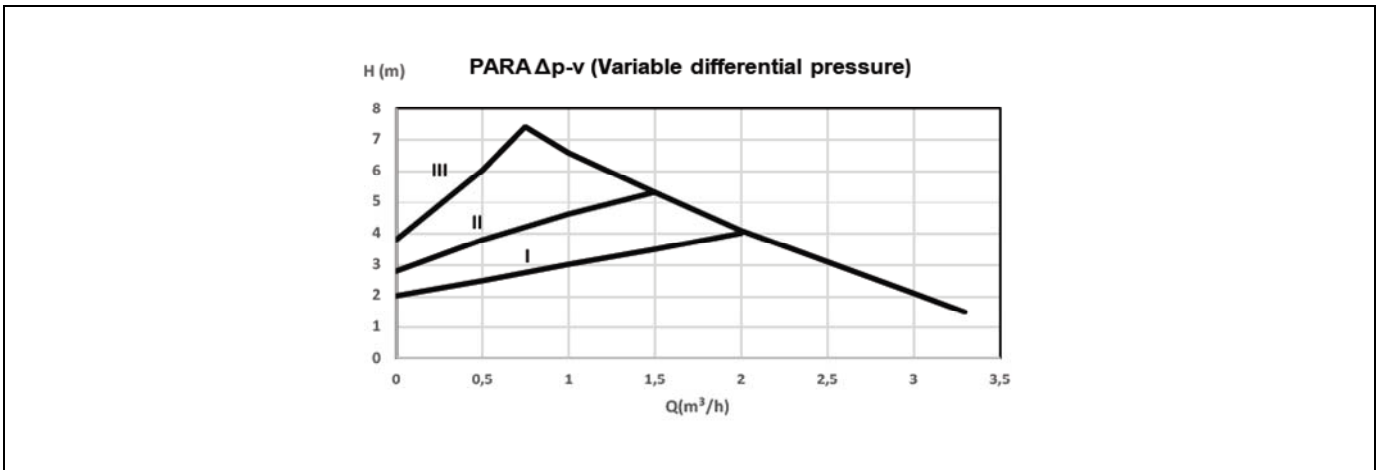

Characteristic curve of the circulation pump for the constant differential pressure mode:

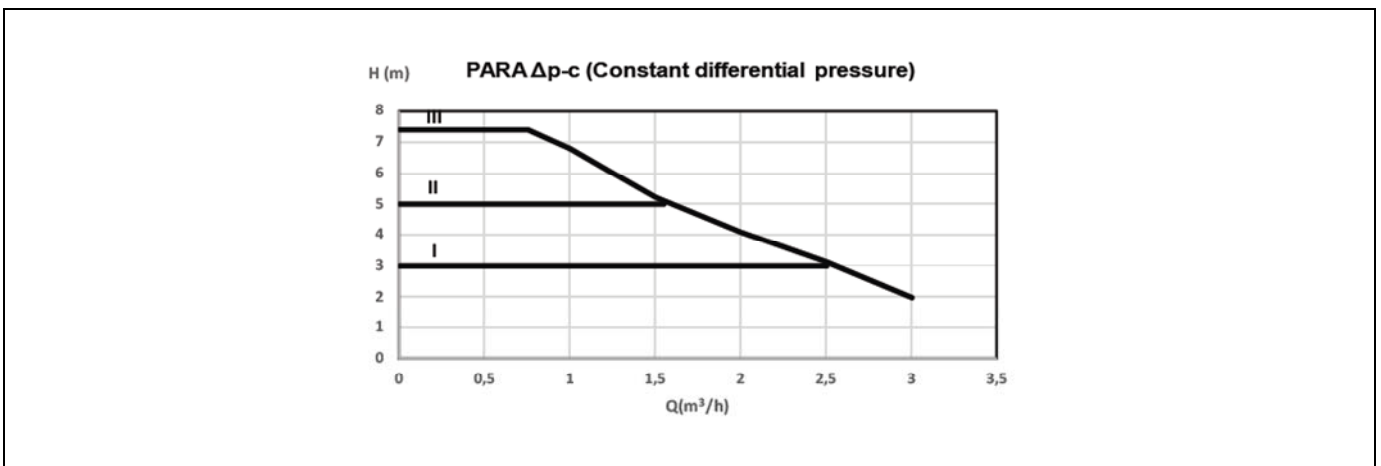

BioClass HM

29 SPARE PARTS LIST

Boiler

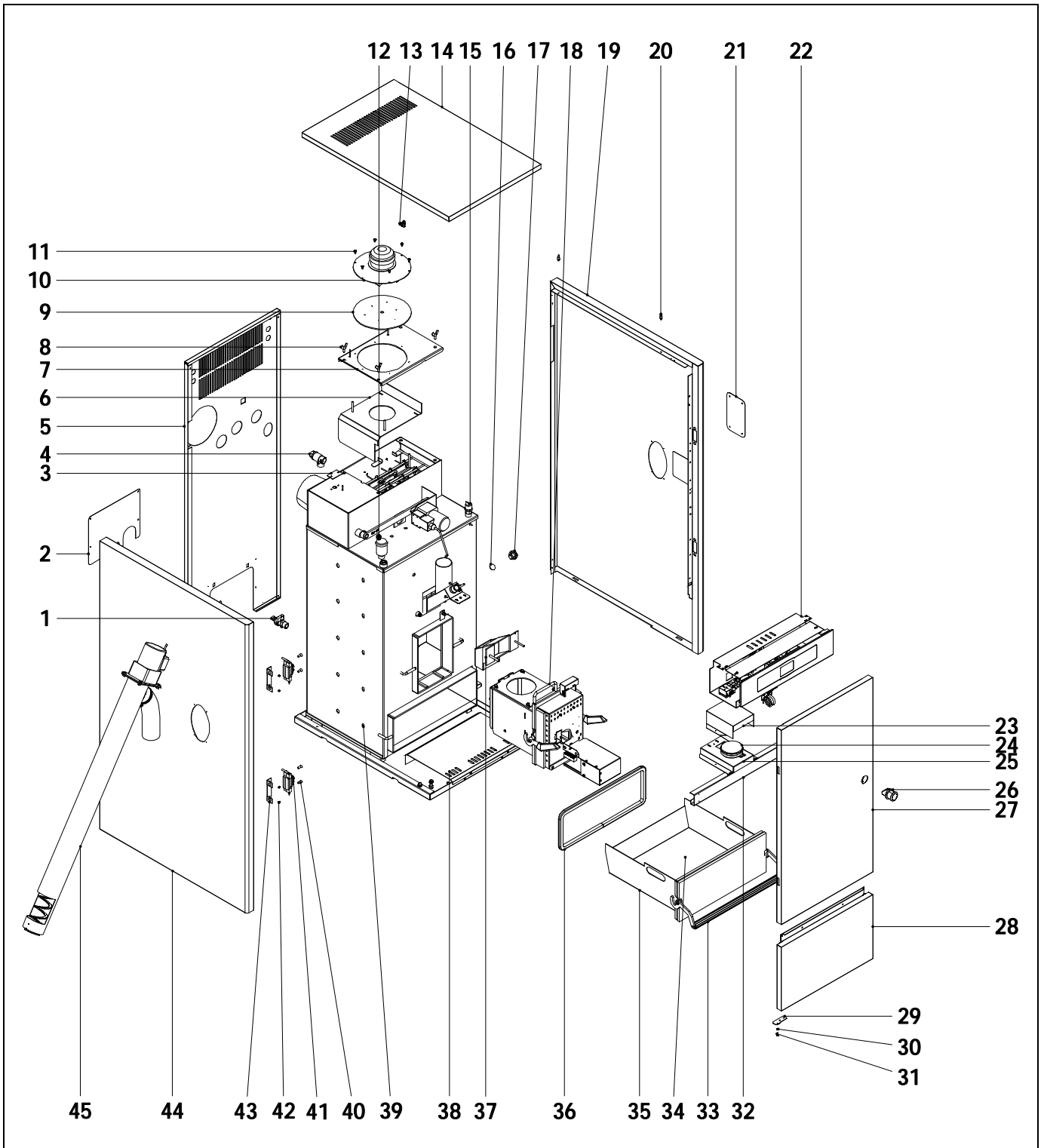

Nº.	Code	Name	Nº.	Code	Name
1	CVAL000034	Drain valve	30	CTOR000179	DIN-6798-A M4 washer
2	SEPO001832	Rear cover HM 10	31	CTOR000071	DIN-933 M4X10 screw
	SEPO001165	Rear cover HM 10/16/25	32	SEPO002194	Stiffness BioClass HM 10/16
3	SCHA009633	Exhaust hole cover		SEPO002233	Stiffness BioClass HM 25/43
4	CVAL000017	Safety valve	33	RBIO000038	Ash drawer handle BioClass HM 10
5	SEPO001785	Rear panel BioClass HM 10		RBIO000039	Ash drawer handle BioClass HM 16
	SEPO001747	Rear panel BioClass HM 16		RBIO000040	Ash drawer handle BioClass HM 25/43
	SEPO001925	Rear panel BioClass HM 25/43	34	RCENBIO008	Ash drawer BioClass HM 10
6	SCON000539	BioClass HM 10 deflector		RCENBIO009	Ash drawer BioClass HM 16
	SCON000493	BioClass HM 16 deflector		RCENBIO010	Ash drawer BioClass HM 25
	SCON000507	BioClass HM 25 deflector		RCENBIO011	Ash drawer BioClass HM 43
	SCON000547	BioClass HM 43 deflector	35	SCON000242	Drawer BioClass HM 10
7	SCON000630	BioClass HM 10 fan cover		SCON000284	Drawer BioClass HM 16
	SCON000631	BioClass HM 16 fan cover		SCON000285	Drawer BioClass HM 25
	SCON000632	BioClass HM 25 fan cover		SCON000286	Drawer BioClass HM 43
	SCON000633	BioClass HM 43 fan cover	36	SAIS000140	Glass braid BioClass HM 10
8	CTOR000183	Butterfly screw		SAIS000141	Glass braid BioClass HM 16
9	SAIS000136	Fan insulation BioClass HM 10		SAIS000142	Glass braid BioClass HM 25/43
	SAIS000137	Fan insulation BioClass HM 16-25	37	RBIO000035	Internal supply Line BioClass HM 10/16
	SAIS000138	Fan insulation BioClass HM 43		RBIO000008	Internal supply Line BioClass HM 25/43
10	RBIO000004	Fan BioClass HM 10	38	SEPO002198	Ash drawer chute HM 10/16/25
	RBIO000005	Fan BioClass HM 16/25		SEPO002219	Ash drawer chute HM 43
	RBIO000009	Fan BioClass HM 43	39	RBIO000027	Heat exchanger BioClass HM 10
11	CTOR000016	Fan screw		RBIO000028	Heat exchanger BioClass HM 16
12	GFOV000002	Automatic air vent		RBIO000029	Heat exchanger BioClass HM 25
13	CFER000048	Spring		RBIO000030	Heat exchanger BioClass HM 43
14	SEPO002193	Top Cover BioClass HM 10/16	40	CTOR000253	DIN-7991 M6X16 screw
	SEPO002205	Top Cover BioClass HM 25	41	CFER000221	Hinge
	SEPO002371	Top Cover BioClass HM 43	42	CFER000286	Black rivet 4x8
15	CELC000252	Pressure transducer	43	SCHA011030	Rivet support
16	COTR000010	Spy hole glass	44	SEPO002191	Left side panel BioClass HM 10/16
17	CFOL000002	Spy hole nut		SEPO002206	Left side panel BioClass HM 25
18	RQUEBIO015	Burner BioClass HM 10/16		SEPO002329	Left side panel BioClass HM 43
	RQUEBIO016	Burner BioClass HM 25	45	RALMBIO003	Supply Line BioClass HM 10 / 16
	RQUEBIO018	Burner BioClass HM 43		RALMBIO009	Supply Line BioClass HM 25
19	SEPO002192	Right side panel BioClass HM 10/16		RALMBIO012	Supply Line BioClass HM 43
	SEPO002207	Right side panel BioClass HM 25			
	SEPO002341	Right side panel BioClass HM 43			
20	CTOE000012	Pivot			
21	SEPO001430	Cover for oval hole			
22	RELEBIO008	Electrical board BioClass HM 10			
	RELEBIO009	Electrical board BioClass HM 16			
	RELEBIO010	Electrical board BioClass HM 25			
	RELEBIO012	Electrical board BioClass HM 43			
23	SEPO002196	Air pressure sensor protection			
24	CELC000331	Air pressure sensor			
25	SEPO001770	Air pressure sensor support			
26	CFER000220	Latch			
27	RBIO000023	Door BioClass HM 10/16			
	RBIO000024	Door BioClass HM 25/43			
28	RBIO000025	Lower door BioClass HM 10/16			
	RBIO000026	Lower door BioClass HM 25/43			
29	SEPO002203	Lower door shaft			

BioClass HM

Burner

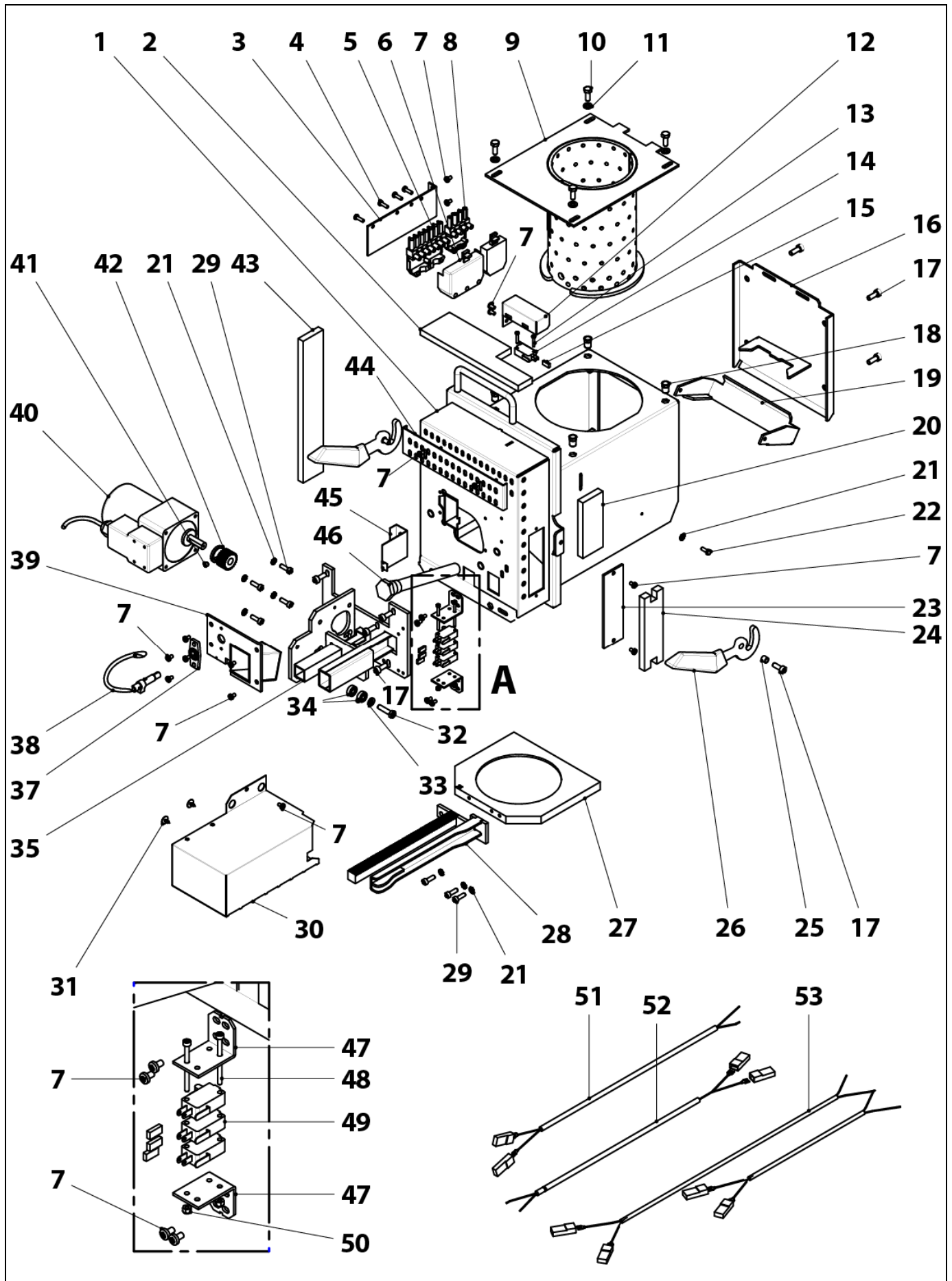

Nº.	Código	Name	Nº.	Código	Name
1	SCON001148	Burner body HM 10-16	41	CTOR000257	DIN-916 M6x6 stud
	SCON000935	Burner body HM 25	42	RCON000011	Pinion sub-unit
	SCON001084	Burner body HM 43	43	MAIS000159	Left side insulation HM 10-16-25
2	MAIS000158	Top insulation HM 10-16		MAIS000165	Left side insulation HM 43
	MAIS000162	Top insulation HM 25	44	SEPO001765	Air regulation cover HM 10-16
	MAIS000163	Top insulation HM 43		SEPO001807	Air regulation cover HM 25-43
3	SEPO002175	Connectors support	45	SCHA009399	Photocell cap
4	CTOR000100	Screw for plastic 4,1x16	46	CRES000035	Electrical resistor
5	CQUE000042	7-pole connector	47	SEPO002105	Cleaner sensor support
6	CQUE000135	7-pole connector cover	48	CTOR000064	DIN-912 M3x40 black screw
7	CTOR000242	DIN-7985 M4x7 screw	49	CELC000332	Cleaner sensor
8	CQUE000303	4-pole connector	50	CTOR000280	DIN-934 M3 nut
9	RCON000004	Burning pot 10-16	51	CELC000357	Cleaner sensor cable (Black)
	RCON000005	Burning pot 25	52	CELC000356	Cleaner sensor cable (Brown)
	RCON000006	Burning pot 43	53	CELC000346	Burner harness
10	CTOR000222	DIN-933 M6x16 INOX. screw			
11	CTOR000223	DIN-125-A2 M6 INOX. washer			
12	SEPO002174	Burner position sensor cover			
13	CTOR000209	DIN-7985 M3x15 screw			
14	CELC000327	Burner position sensor.			
15	CELC000352	Cap			
16	SCON001293	Rear burner cover 10/16			
	SCON001294	Rear burner cover. 25			
	SCON001295	Rear burner cover. 43			
17	CTOR000265	DIN-912 M6x14 screw			
18	CTOR000226	Blind rivet nut			
19	SCON001290	Flap HM 10-16			
	SCON001291	Flap HM 25			
	SCON001292	Flap HM 43			
20	MAIS000161	Right side insulation HM 10-16-25			
	MAIS000164	Right side insulation HM 43			
21	CTOR000108	DIN-6798-A M5 washer			
22	CTOR000102	DIN-933 M4x8 screw			
23	SCON001296	Burner body cover			
24	MAIS000166	Cover insulation			
25	CTOE000168	Sleeve bushing			
26	CQUE000177	Lever			
27	CFUR000034	Burner cleaner HM 10-16			
	CFUR000032	Burner cleaner HM 25			
	CFUR000033	Burner cleaner HM 35-43			
28	RCON000007	Rack sub-unit HM 10-16			
	RCON000008	Rack sub-unit HM 25			
	RCON000009	Rack sub-unit HM 35-43			
29	CTOR000266	DIN-912 M5x16 screw			
30	RBIO000033	Protection cover HM 10-16-25			
	RBIO000034	Protection cover HM 43			
31	CTOR000214	4,2 x 13 black screw			
32	CTOR000146	DIN-933 M6x25 screw			
33	CTOR000084	DIN-125-A2 M6 washer			
34	CFER000129	696 2Z bearing			
35	RCON000010	Motor support			
37	CQUE000224	Photocell support			
38	CQUE000220	Photocell			
39	SEPO002109	Burner cover			
40	CFOV000147	Motor			

BioClass HM

Heat exchanger camshaft system

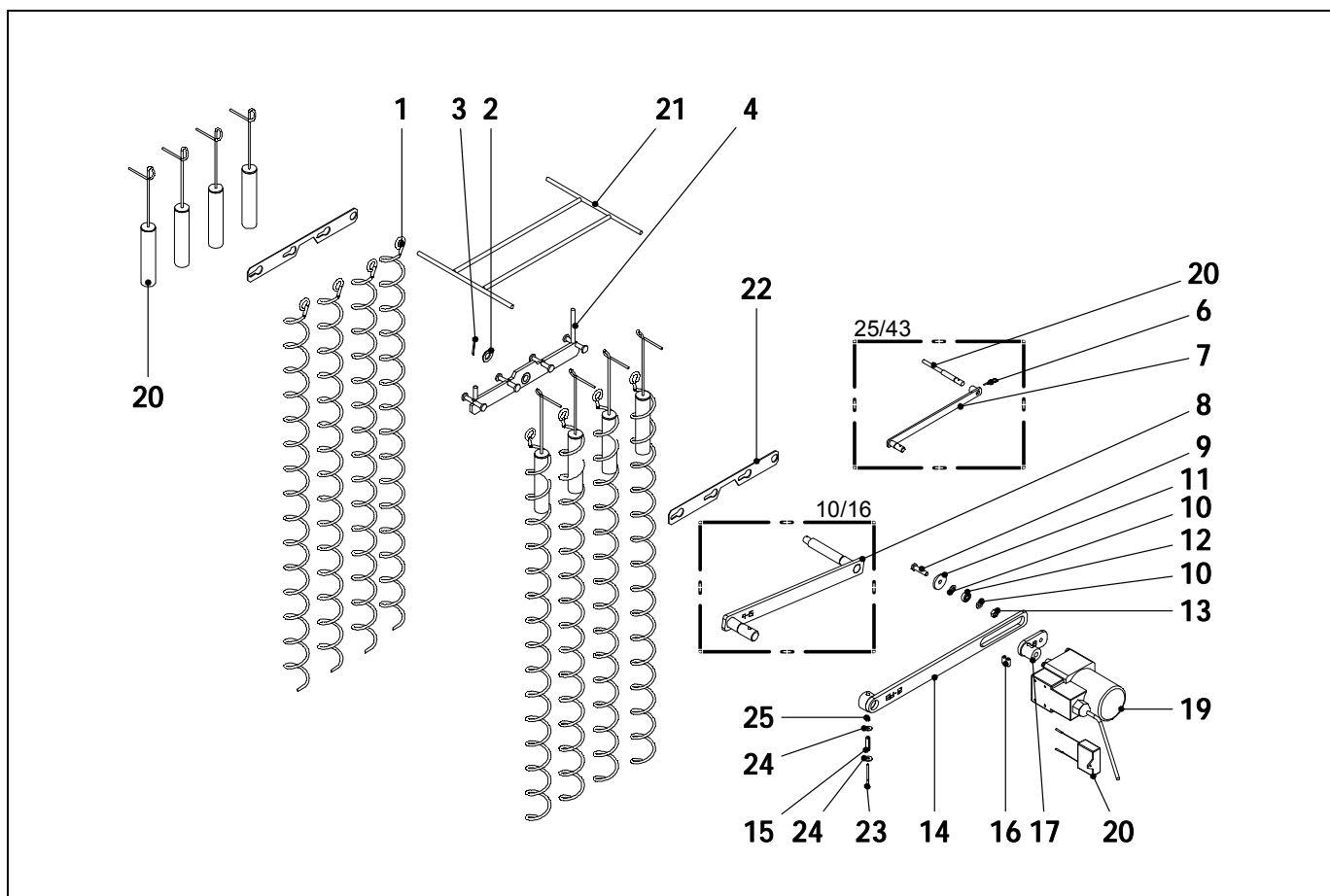

N°.	Code	Name	N°.	Code	Name
1	CTOE000241	Deflector coil HM 10/16	17	SCON000307	Transmission crank sub-unit
	CTOE000242	Deflector coil HM 25/43	18	CFOV000140	YN 60 capacitor
2	CTOR000162	Flat DIN-125-A M10		CFOV000141	BioClass HM 10/16/25
3	CFER000284	Blade pin			YN 70 capacitor
4	SCON000619	Cleaning plate sub-unit 10	19	CFOV000134	BioClass HM 43
	SCON000620	Cleaning plate sub-unit 16			10 W motor transmission 1/180
	SCON000302	Cleaning plate sub-unit 25			BioClass HM 10/16/25
	SCON000331	Cleaning plate sub-unit 43		CFOV000135	20 W motor transmission 1/180
5	CTOE000289	Inner shaft BioClass HM 25			BioClass HM 43
	CTOE000270	Inner shaft BioClass HM 43	20	SCON000758	Deflector tube sub-unit 16
6	CFER000289	Pin BioClass HM 25		SCON000756	Deflector tube sub-unit 25/43
7	SCON000303	Inner plate sub-unit 25	21	SCON000757	Deflector tube support 16
	SCON000332	Inner plate sub-unit 43		SCON000752	Deflector tube support 25
8	SCON000304	Inner plate sub-unit 10		SCON000765	Deflector tube support 43
	SCON000463	Inner plate sub-unit 16	22	SCHA011027	Plate fastener 10
9	CTOR000146	DIN-933 M6x25 screw		SCHA011031	Plate fastener 16
10	CTOR000084	DIN-125-A M6 washer		SCHA010996	Plate fastener 25/43
11	CTOE000172	Cam system washer	23	CTOR000279	DIN-912 M3x40 screw
12	CFER000129	Bearing	24	CTOR000132	DIN-9021 M4 washer
13	CTOR000230	Self-locking hex nut	25	CTOR000280	DIN-985 M3 nut
14	SCON000305	Outer plate sub-unit 10/16			
	SCON000306	Outer plate sub-unit 25/43			
15	CFER000292	Elastic pin			
16	CTOR000218	DIN-913 M6x10 stud			

Feed auger

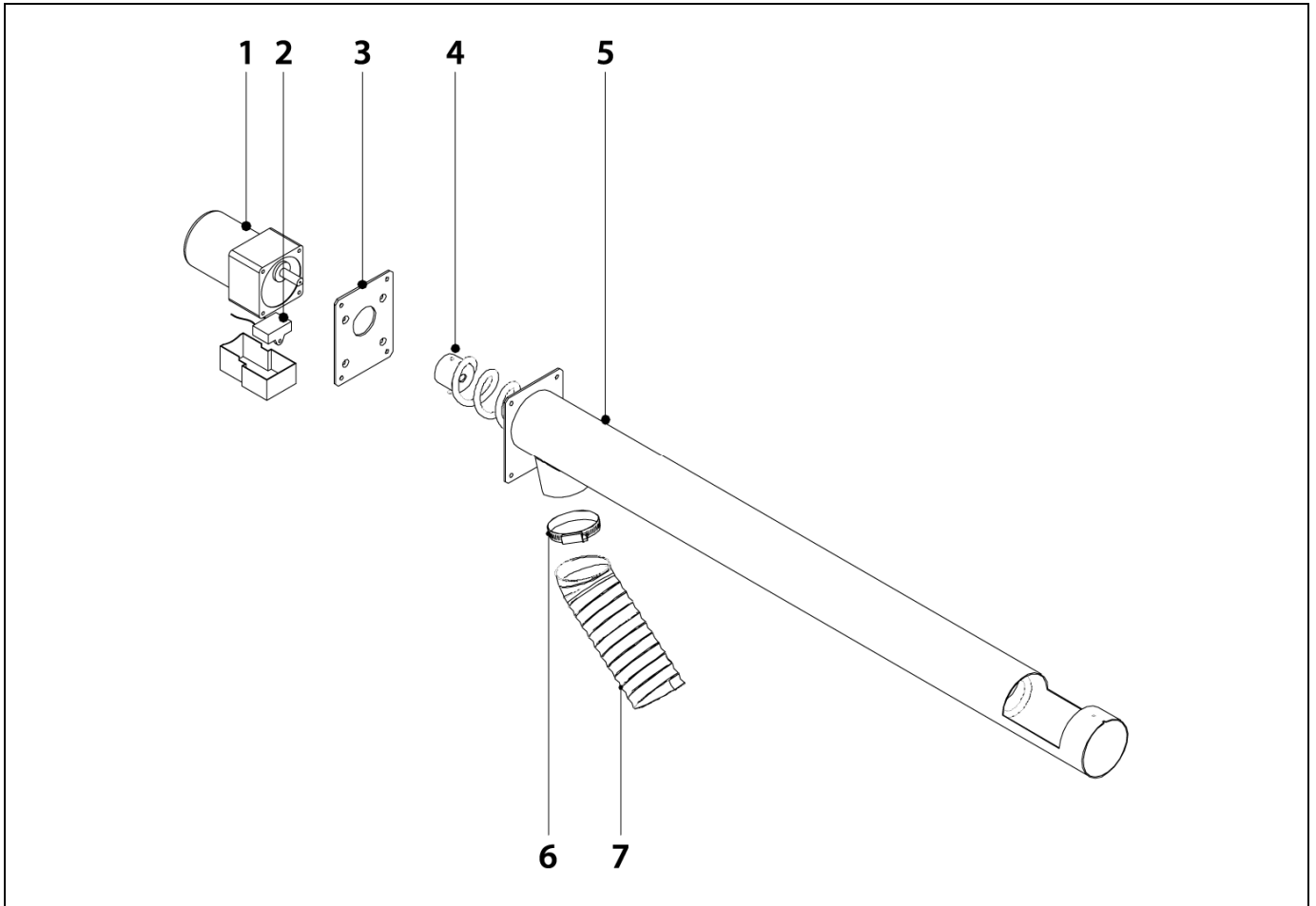

<u>N°.</u>	<u>Code</u>	<u>Name</u>
1	CFOV000136	25W motor transmission 1/180
2	CFOV000142	YN 80 capacitor
3	SEPO001637	Fixing plate
4	SCON000578	Feed Screw 10/16
	SCON000579	Feed Screw 25/43
5	SEPO001611	Feed tube 10/16
	SEPO001612	Feed tube 25/43
6	CFER000019	Clamp
7	STUR000004	Polyurethane flex hose HM 10-16-25
	STUR000005	Polyurethane flex hose HM 43

BioClass HM

Electrical board

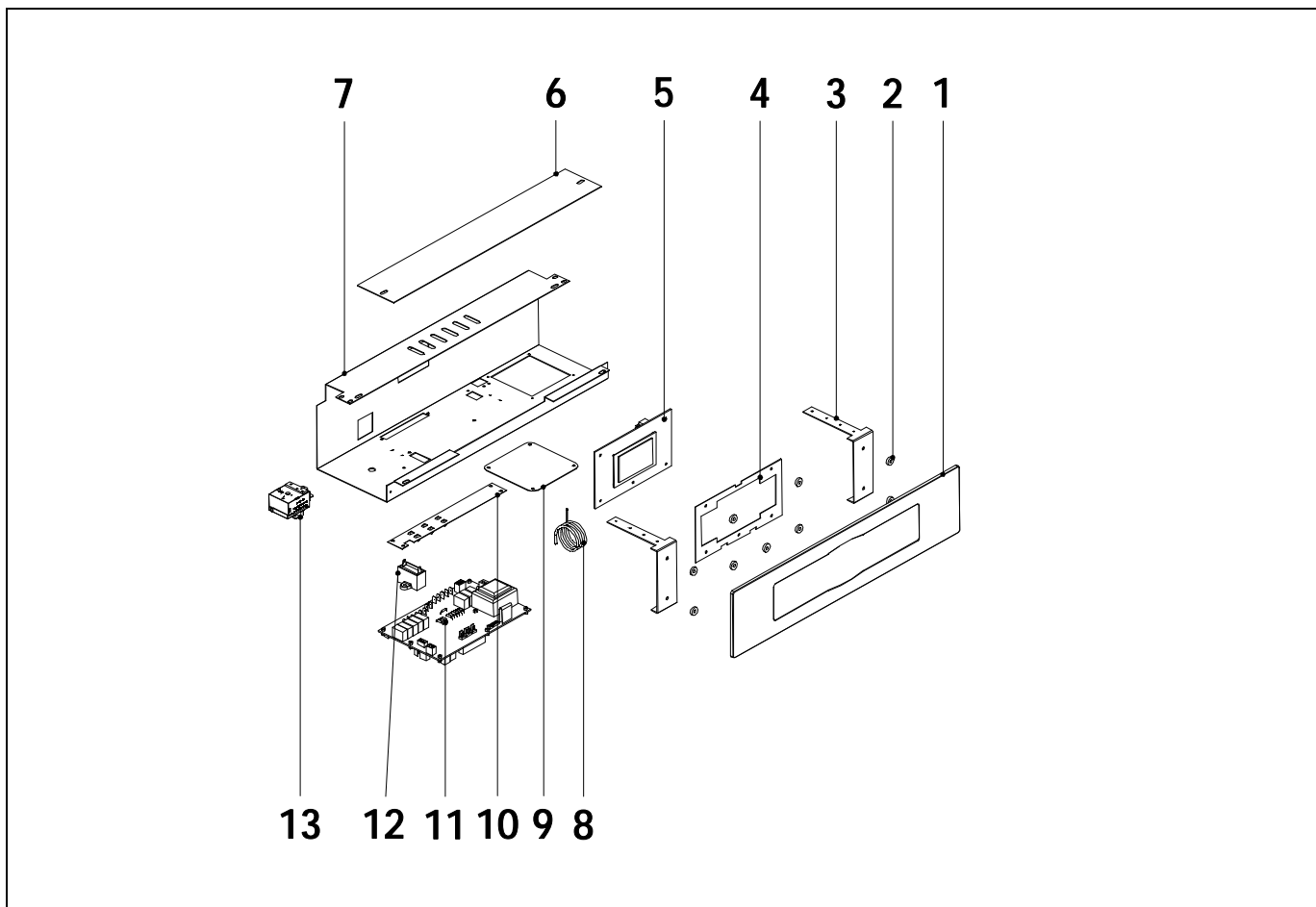

<u>N°.</u>	<u>Code</u>	<u>Description</u>
1	RBIO000031	Electrical board BioClass HM 10-16
	RBIO000032	Electrical board BioClass HM 25-43
2	CFER000064	Nylon washer
3	SEPO001303	Panel fastening
4	SCHA009564	Display fixing
5	REBI336XXX	Display card BioClass HM
6	SEPO001304	Drawer cover
7	SEPO002185	Drawer BioClass HM 10-16
	SEPO002212	Drawer BioClass HM 25-43
8	CELC000234	Boiler sensor
9	SEPO001740	Kit aspiration HM cover
10	SCHA009150	Ground plate
11	REBI335XXX	Supply electronic card BioClass HM
12	CFOV000121	Fan motor capacitor BioClass HM 10
	CFOV000133	Fan motor capacitor BioClass HM 16-25
	CFOV000151	Fan motor capacitor BioClass HM 43
13	CELC000022	Safety thermostat 110 °C

Wiring

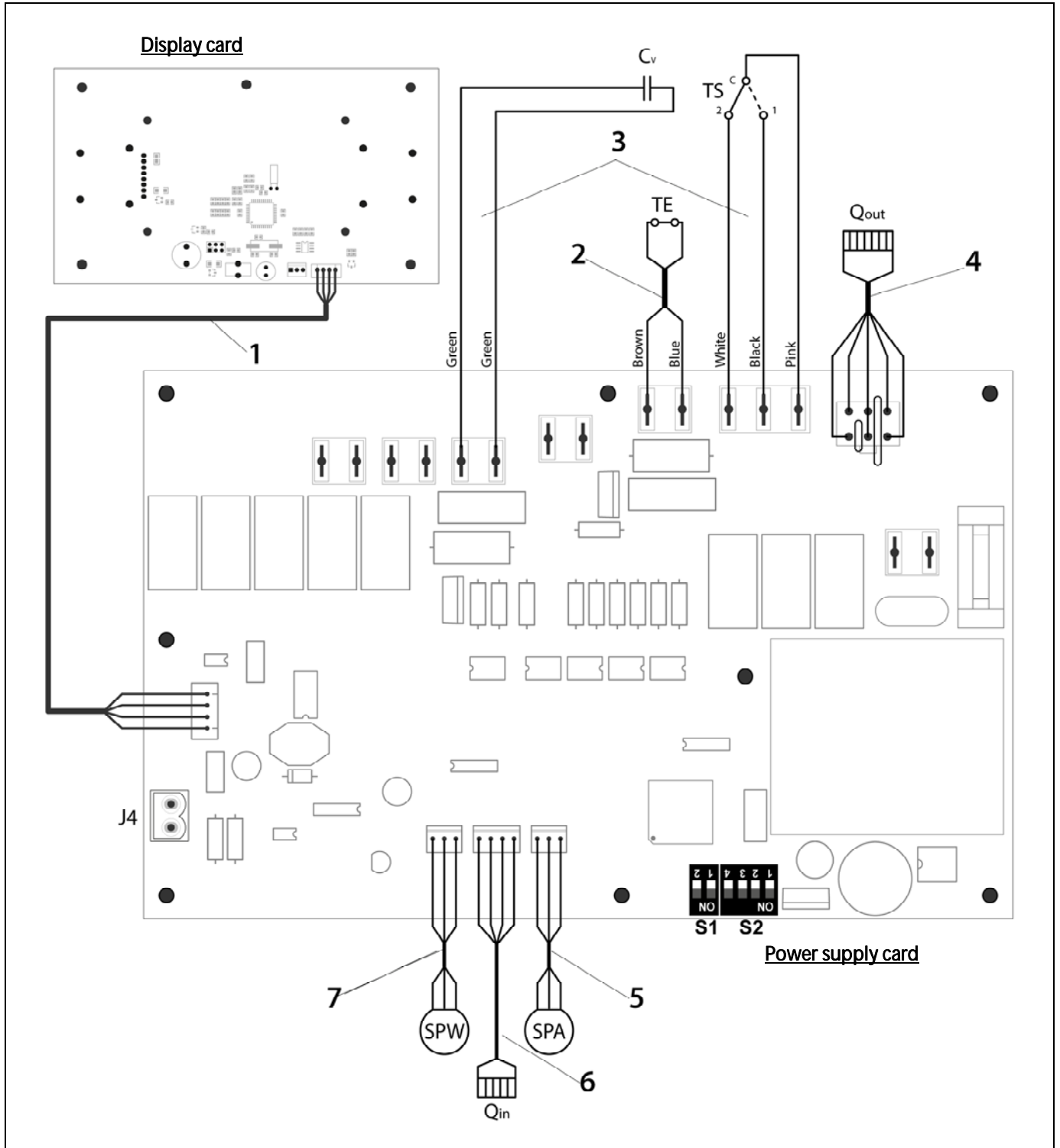

Nº.	Code	Name
1	CELC000343	Communication cable
2	CELC000353	Thermostat cable
3	CMAZ000123	Wiring harness
4	CELC000344	Burner output cable
5	CELC000345	Air pressure sensor cable
6	CELC000348	Burner input cable
7	CELC000349	Water pressure sensor cable

BioClass HM

30 TECHNICAL DATA

MODEL		BioClass HM 10	BioClass HM 16	BioClass HM 25	BioClass HM 43
Rated heat output (P_n)	kW	12	18	25,3	45
Efficiency at maximum heat output	% (NCV)	93,1	94	93,1	94,2
Minimum heat output (P_p)	kW	3,6	5,2	7,6	12,8
Efficiency at minimum heat output	% (NCV)	90	90,6	93,2	93,1
CO at maximum heat output (10% O ₂)	mg/m ³	32	7	23	87
OGC (organic gaseous substances) at maximum heat output (10% O ₂)	mg/m ³	3	4	2	2
Particles content at maximum heat output (10% O ₂)	mg/m ³	4	9	3	19
CO at minimum heat output (10% O ₂)	mg/m ³	272	84	164	91
OGC (organic gaseous substances) at minimum heat output (10% O ₂)	mg/m ³	19	3	3	3
Boiler class (according to EN 303-5)	-	Clase 5			
Maximum operating pressure	bar	3			
Maximum operating temperature	°C	80			
Maximum safety temperature	°C	110			
Water volume	litros	46	55	73	104
Minimum flue draught	mbar	0,10			
Maximum flue draught	mbar	0,20			
Electrical supply	-	230 V~, 50 Hz, 2,50 A			
Boiler chimney diameter	mm	125	125	150	150
Maximum water content of the fuel	%	7			
Minimum return temperature	°C	25 °C			
Water pressure drop (dT = 20 K)	mbar	30	70	140	180
Weight (net)	Kg	190	211	300	368

MODEL			BioClass HM 10	BioClass HM 16	BioClass HM 25	BioClass HM 43
Rated heat output (P_n)		kW	12	18	25,3	45
Efficiency at maximum heat output (η_n)		% (GCV)	85,2	86,0	85,2	86,2
Minimum heat output (P_p)		kW	3,6	5,2	7,6	12,8
Efficiency at minimum heat output (η_p)		% (GCV)	82,4	82,9	85,3	85,2
Feeding mode		-	Automatic *			
Condensing boiler		-	No			
Combined boiler		-	No			
Cogeneration boiler		-	No			
Combustible		-	Wood pellet Ø6 - 8 mm. Maximum length 35 mm.			
Seasonal yield (η_s)		%	79	79	81	82
Seasonal heating emissions	Part.	mg/m ³	17	13	5	19
	COG	mg/m ³	16	3	3	3
	CO	mg/m ³	236	73	57	91
	NO _x	mg/m ³	135	148	147	160
Electricity consumption at nominal power ($e_{l_{max}}$)		kW	0,024	0,044	0,067	0,077
Electricity consumption at 30% nominal power ($e_{l_{min}}$)		kW	0,012	0,025	0,026	0,029
Electricity consumption in standby mode (P_{SB})		kW	0,004	0,004	0,004	0,004
Energy Efficiency Index - EEI		-	116	117	120	120

* It is recommended to use the boiler with a hot water storage tank of a minimum volume of 20 x P_n with P_n indicated in kW.

31 ALARM CODES

BioClass HM boiler is equipped with an electronic controller that performs continuous self-testing to detect any boiler malfunctioning. When it detects a functioning error, this is indicated by an alarm code on the display. The table below shows the list of the alarm codes:

CODE	ALARM	DESCRIPTION
E-01	Boiler temperature sensor open circuit, S_c .	The boiler sensor is damaged or disconnected. Contact your nearest official technical assistance service to have it replaced.
E-02	Boiler temperature sensor short-circuited, S_c .	
E-03	DHW temperature sensor open circuit, S_a .	The DHW sensor is damaged or disconnected. Contact your nearest official technical assistance service to have it replaced.
E-04	DHW temperature sensor short-circuited, S_a .	
E-05	Overheating in fuel entrance tube, Te .	The security thermostat of fuel entrance tube has exceeded the safety temperature of 80 °C. The boiler will lock out. To unlock the boiler wait the temperature drops, press the button on the safety thermostat and restore by pressing RESET button. If this alarm occurs repeatedly contact the nearest official technical assistance service.
E-06	Ignition failure.	Check the fuel content in the hopper or calibrate the feed auger. If this alarm occurs repeatedly contact the nearest official technical assistance service.
E-07	Burner ash cleaning system start step error.	These alarms occur when a bad running of the burner ash cleaning system is detected. If this alarm occurs repeatedly contact the nearest official technical assistance service.
E-08	Burner ash cleaning system final step error.	
E-09	Burner ash cleaning system switch error, FC_p .	
E-10	Boiler water overheating.	The water in the boiler has exceeded the safety temperature of 100 °C. The boiler will lock out. The boiler will be unlocked automatically when the boiler temperature drops below 90 °C. If this alarm occurs repeatedly contact the nearest official technical assistance service.
E-11	Safety thermostat, Ts .	The water in the boiler has exceeded the safety temperature of 110 °C. The boiler will cut out.. To unlock it, wait until the boiler drops below 100 °C and press the button on the safety thermostat. If this alarm occurs repeatedly contact the nearest official technical assistance service.
E-12	Burner switch, FC_q .	Check if the burner is correctly fitted to the boiler. If this alarm occurs repeatedly contact the nearest official technical assistance service.
E-13	Insufficient air depression.	Check the correct running and connection of the air pressure sensor and that the burner and ashtray are correctly fitted to the boiler. If this alarm occurs repeatedly contact the nearest official technical assistance service.
E-14	Air depression fall down.	
E-15	Insufficient air depression during ignition pre-purge step.	
E-18	Water pressure sensor fault.	The water pressure sensor is damaged or disconnected. Contact your nearest official technical assistance service to have it replaced.

CODE	ALARM	DESCRIPTION
E-19	Low water pressure.	The pressure of water in the installation drops below the minimum pressure set at P.19 parameter of the " <i>Technical Menu</i> " (by default 0,5 bar). The boiler will lock out. To unlock it, fill the installation again up to 1 - 1.5 bar. This alarm occurs when the water is drained from the installation, due to either leakage or maintenance operations. If this alarm occurs repeatedly contact the nearest official technical assistance service.
E-20	Safety valve fault.	When the installation pressure exceeds 3.5 bar, this alarm is displayed on the screen. The safety valve is damaged or it doesn't work properly. The boiler will lock out. The boiler will be unlocked, when the pressure drops below 2.5 bar again. Drain the installation up to 1 - 1.5 bar. Contact your nearest official technical assistance service to have it replaced.
E-21	Air pressure sensor fault.	The air pressure sensor is damaged or disconnected. Contact your nearest official technical assistance service to have it replaced.
E-22	Excessive air depression in the combustion chamber.	The air depression measured in the combustion chamber exceeds the limits of the air pressure sensor. The burner will be locked until the depression is correct again. If this alarm occurs repeatedly contact the nearest official technical assistance service.
E-23	Excessive air overpressure in the combustion chamber.	The air overpressure measured in the combustion chamber exceeds the limits of the air pressure sensor. The burner will be locked until the depression is correct again. If this alarm occurs repeatedly contact the nearest official technical assistance service.
E-25	Wrong calibration data.	The calibration data is wrong or it is set at OFF value. If this alarm occurs repeatedly contact the nearest official technical assistance service.
E-26	Communication error with CVS Suction System .	Communication failure between boiler and CVS Suction System. The kit will lock out. When the communication is restored CVS Suction System will be unlocked. If this alarm occurs repeatedly contact the nearest official technical assistance service.
E-27	CVS Suction System blockage.	If the level sensor continues to detect no fuel after 8 consecutive cycles, CVS Suction System will lock out. To unlock it press RESET button. If this alarm occurs repeatedly contact the nearest official technical assistance service.
E-28	Overpressure of water.	When the boiler water pressure exceeds 2.5 bar, this alarm is displayed on the screen to warn of an excess of pressure in the installation. To restore the normal functioning of the boiler it is recommended to drain the installation again up to 1 - 1.5 bar If this alarm occurs repeatedly contact the nearest official technical assistance service.
E-29	Fuel level sensor error.	Fuel level sensor is damaged or disconnected. Contact your nearest official technical assistance service to have it replaced.
E-30	Underfloor temperature sensor open circuit, Sr1 .	Underfloor temperature sensor is damaged or disconnected. Contact your nearest official technical assistance service to have it replaced.
E-31	Underfloor temperature sensor short-circuited, Sr1 .	

BioClass HM

CODE	ALARM	DESCRIPTION
E-32	Underfloor temperature sensor open circuit, Sr2 .	Underfloor temperature sensor is damaged or disconnected. Contact your nearest official technical assistance service to have it replaced.
E-33	Underfloor temperature sensor short-circuited, Sr2 .	
E-34	Outdoor temperature sensor open circuit, Sext .	Outdoor temperature sensor is damaged or disconnected. Contact your nearest official technical assistance service to have it replaced.
E-35	Outdoor temperature sensor short-circuited, Sext .	
E-36	DIP-switch wrongly changed.	DIP-switch selector of the boiler is changed when the boiler is connected to the main supply. The boiler will be locked out until unplug and plug the boiler again.
E-37	Communication error with BIO Hydraulic Kit .	Communication failure between boiler and the BIO Hydraulic Kit . If this alarm occurs repeatedly contact the nearest official technical assistance service.
E-38	Lasting insufficient air depression during ignition pre-purge step.	Check the air pressure sensor and that the burner and ashtray are correctly fitted to the boiler. If this alarm occurs repeatedly contact the nearest official technical assistance service.
E-39	Insufficient fan speed.	Fan malfunction. If this alarm occurs repeatedly contact the nearest official technical assistance service.
E-40	Fan speed fall down.	
E-41	Lasting fan speed fall down.	
E-42	Communication error with BIO Hydraulic Kit .	Communication failure between boiler and the BIO Hydraulic Kit . If this alarm occurs repeatedly contact the nearest official technical assistance service.
E-43	Ashtray full.	Warning that the ashtray is full. The boiler will continue operate normally. To restore warning, the ashtray must be emptied and it is necessary to set the "Emptying ashes" parameter to 0 of the "User menu" (See "Ashtray status").
E-44	Boiler Maintenance.	Notice for maintenance of the boiler. Contact your nearest official technical assistance service to perform periodic maintenance of the boiler.
E-45	BT tank temperature sensor open circuit, Sbt .	BT tank temperature sensor is damaged or disconnected. Contact your nearest official technical assistance service to have it replaced.
E-46	BT tank temperature sensor short-circuited, Sbt .	
E-47	Communication error with pellets level sensing unit.	Communication failure between boiler and the pellets sensing system board (PCB). If this alarm occurs repeatedly contact the nearest official technical assistance service.
E-48	Low fuel level in the hopper.	Warning that the hopper is going to run out of pellets (fuel reserve). The boiler will continue operate normally. Refill the hopper with pellets up to the sensor to restore the warning alarm.
E-49	Hopper is run out of fuel.	The hopper is completely empty of pellets. The boiler stops running to avoid emptying the auger. To restore boiler functioning refill the hopper with pellets up to the sensor and press RESET button.
E-50	CVS Suction System and pellets sensing units connected together.	CVS Suction System and pellets sensing units are connected together to boiler's main board. Contact your nearest official technical assistance service to disconnect one of the units.

DOMUSA

T E K N I K

POSTAL ADDRESS

Apartado 95
20730 AZPEITIA
Spain

HEADQUARTERS & FACTORY

B° San Esteban s/n
20737 RÉGIL (Guipúzcoa)
Tel: (+34) 943 813 899

www.domusatechnik.com

DOMUSA TEKNIK reserves the right to make modifications of any kind to its product characteristics without prior notice.



CDOC001483

24/09/20